



# BS-1638, BS-1642, BS-1646

**Conventional fire detection panels 8, 12 and 16  
Zones**



**Installation  
Programming  
Use**

**WARNING!!! READ THE WHOLE MANUAL BEFORE EVERY INSTALLATION**



for a safer world!

Date	10/6/2022
File	
Document code	921163800_09_008
Page	2 from 47

## Contents

<b>1 General information</b>	<b>4</b>
1.1 Description	4
1.2 Safety	4
1.3 Indicators and controls	5
1.3.1 Fascia of the panel	5
1.3.2 Keyboard of panel	6
1.3.3 Indication LEDs	7
<b>2 Functions</b>	<b>8</b>
2.1 Operation states of the panel	8
2.2 Normal operation - quiescent state	8
2.3 Alarm State	9
2.4 Fault state	10
2.5 Access Level 1 functions	11
2.6 Basic menu for Access Level 1	12
2.6.1 Events Menu	13
2.6.2 Test Led	13
2.7 Information	14
2.7.1 Zone Information	15
<b>3 User Menu</b>	<b>17</b>
3.1 Enable – Disable menu	19
3.2 Delay menu	19
3.3 Adjusting the time and date	19
3.4 Changing the user code	20
3.5 Use a P/C to access the user menu	21
3.5.1 Using a personal computer	21
3.5.2 Panel information	22
3.5.3 Zone Information	22
3.5.4 All events	23
3.5.5 Network Information	23
3.5.6 User Menu	23
<b>4 Installation</b>	<b>24</b>
4.1 Safety	24
4.2 Installation	24
4.2.1 Mounting the panel on the wall	25
4.3 Cables	26
4.4 Describing the interior of the panel	27
4.5 Connecting the power supply cables (220-240V AC)	27
4.6 Connecting the batteries.	29
4.7 Connecting the Zones	30
4.8 Connecting the Sirens	31



for a safer world!

Date	10/6/2022
File	
Document code	921163800_09_008
Page	3 from 47

4.9 Connection to a network panels -----32

The interface cable is bipolar twisted. The connection topology is parallel so the cable should be passed from one panel to another and there must not be any branches. -----32

They can be connected up 16 panels on a network. -----32

4.10 Other Connections -----33

**5 Technician Menu -----35**

5.1 Test menu -----36

5.2 Setup menu -----37

5.2.1 Number of zones -----37

5.2.2 Sirens-----37

5.2.3 Aux Relay -----37

5.2.4 Network configuration panel -----39

5.3 Settings Menu -----39

5.3.1 Select Language-----39

5.3.2 Annual check warning -----39

5.3.3 Reset defaults -----40

5.3.4 Annual check done-----40

5.3.5 Changing the technician code-----40

5.4 Clearing the events log-----40

5.5 Resetting the alarm counter -----41

5.6 Network settings -----41

5.7 Technician menu using the Ethernet-----41

5.7.1 Zone names -----43

5.7.2 Setting the date and hour-----43

5.7.3 Other information -----44

5.7.4 IP address-----44

**6 Technical Characteristics - Specifications -----45**

6.1 Certification-----47



Date	10/6/2022
File	
Document code	921163800_09_008
Page	4 from 47

## 1 General information

Congratulations for your selection to buy this product.

Olympia Electronics - European manufacturers.

### 1.1 Description

The family consists of 3 panels (8, 12 and 16 zones) with identical controls and indications. They have 2 outputs for sirens, an alarm relay, a fault relay and a programmable auxiliary relay. For their operation, two A-986 (12V/7Ah) batteries are required. Alternatively two A-961 (12V/9Ah) batteries can be used for greater autonomy.

In detail the BS-1638 panel has 8 zones, the BS-1642 has 12 zones and the BS-1646 has 16 zones.

All functions and indications are according to the European norms EN 54-2 and EN 54-4.

The panels offer up to 16 zones and are suitable for large installations such as shopping malls, hotels and factories.

They offer a wide range of settings and characteristics for controlling the installation equipment and sirens which can be easily adjusted using a P/C via an Ethernet connection.

### 1.2 Safety

**A device cannot be considered that it is used correctly if you do not read the accompanying documents that are supplied.**

This product must be installed, commissioned and serviced only by **qualified and trained personnel** according to:

- The regulations concerning the installation of electrical devices in a building.
- The fire safety regulations.
- The instructions of the manufacturer.

- The product operates with a voltage of 220-240V AC/50-60Hz and is a class 1 unit. (For safety and operation reasons it is required that the power earth cable of the building is connected).

- It must be installed to the current electrical installation using a dedicated fuse with a label «**Fire detections system – Do not close the switch**».

### 1.3 Indicators and controls

We can read messages in the graphical display area whereas the LED indicators show basic warnings (alarms, faults, disabled sections).

The front of the panel has all the required controls for its operation.

The operation of the panel is done easily using the 8 button keyboard.

In general we can see:

#### 1.3.1 Fascia of the panel

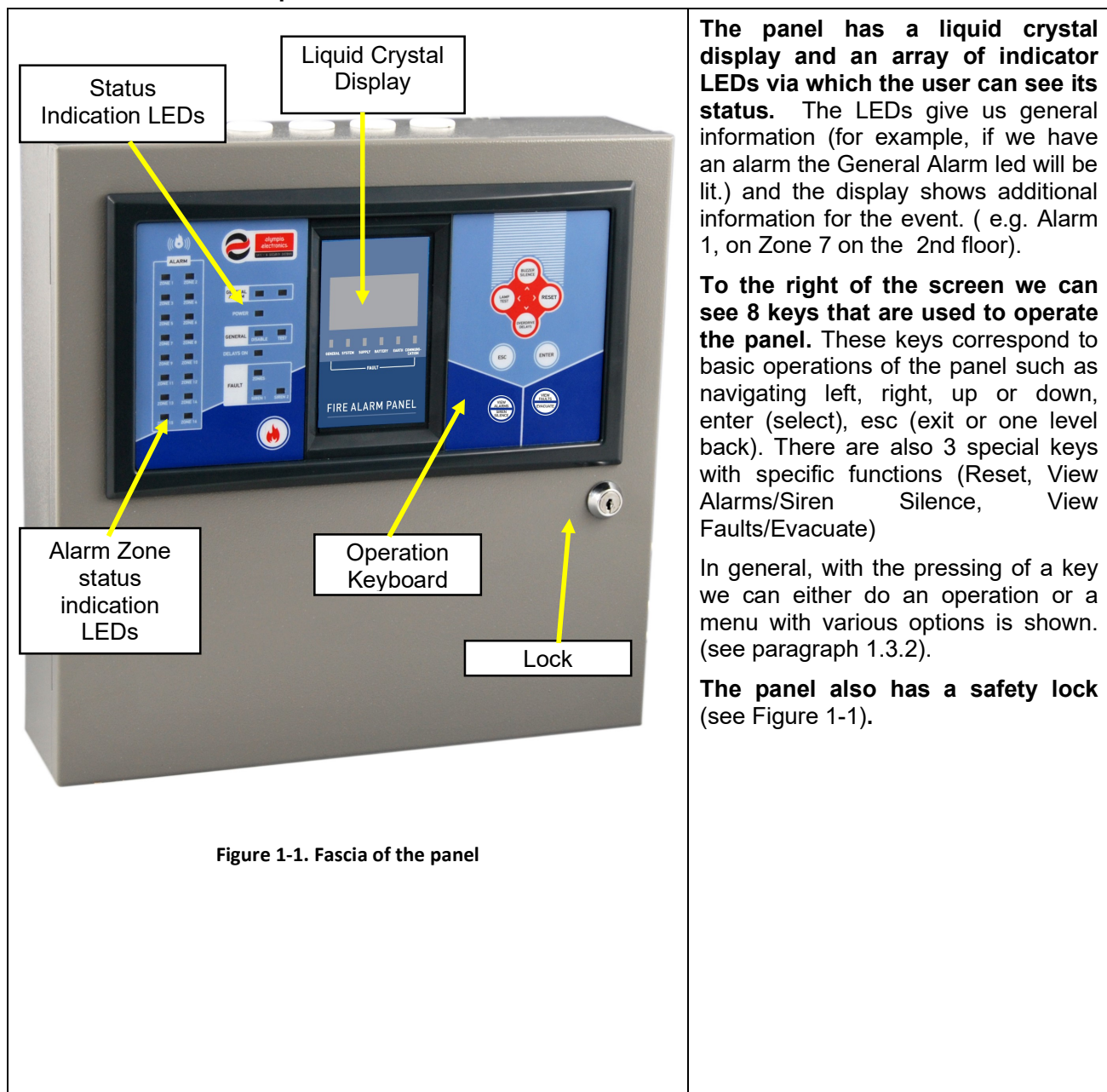

Figure 1-1. Fascia of the panel

The panel has a liquid crystal display and an array of indicator LEDs via which the user can see its status. The LEDs give us general information (for example, if we have an alarm the General Alarm led will be lit.) and the display shows additional information for the event. ( e.g. Alarm 1, on Zone 7 on the 2nd floor).

To the right of the screen we can see 8 keys that are used to operate the panel. These keys correspond to basic operations of the panel such as navigating left, right, up or down, enter (select), esc (exit or one level back). There are also 3 special keys with specific functions (Reset, View Alarms/Siren Silence, View Faults/Evacuate)

In general, with the pressing of a key we can either do an operation or a menu with various options is shown. (see paragraph 1.3.2).

The panel also has a safety lock (see Figure 1-1).



Date	10/6/2022
File	
Document code	921163800_09_008
Page	6 from 47

### 1.3.2 Keyboard of panel

	<b>Buzzer Silence</b>	Used to silence a sounding buzzer.
	<b>Lamp Test</b>	Use this button to conduct a lamp test. All indicators and the screen are activated so we can verify their correct operation.
	<b>Overdrive delays</b>	In case of an alarm when the delays are enabled, the user can override the delays by pressing this button. The output will be activated immediately. (Access Level 2).
	<b>RESET (LONG PRESS 2sec)</b>	Resets the panel from alarm state to quiescent, clears current faults
	<b>Esc</b>	Exiting to the previous menu or Exit.
	<b>Enter</b>	Confirming selection.
	<b>View Alarms (ONE PRESS)</b>	Showing current alarm (if they exist).
	<b>View Faults (ONE PRESS)</b>	Showing current faults (if they exist).
	<b>SIREN SILENCE (LONG PRESS 2sec)</b>	Stops or resumes sirens during alarm mode
	<b>EVACUATE (LONG PRESS 2sec)</b>	Evacuation of the building. Manual Activation of all alarm outputs
	<b>Arrow keys</b>	<p>Navigating in the menu (up / down / left / right) – or moving the cursor.</p> <p>Using the keys up or down we can increase or decrease the value of the counter.</p>

Figure 1-2. Keyboard of the panel

### 1.3.3 Indication LEDs

The LEDs are divided into groups and colorings so the indications are more comprehensive.

In detail, the indications of the LEDs correspond to the following case:

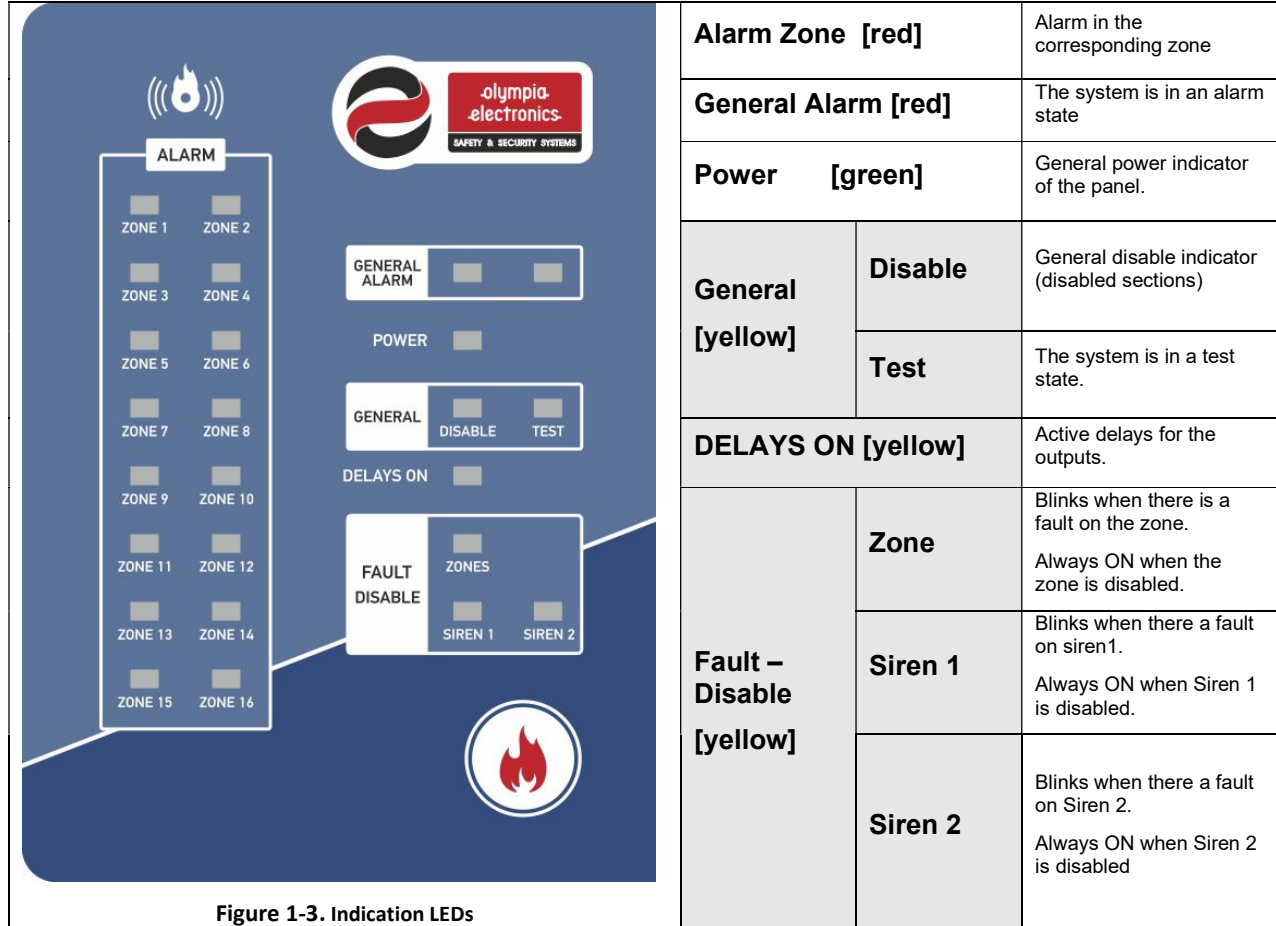

The following figure shows the indicators that are below the LCD screen. All of these indicators are yellow.

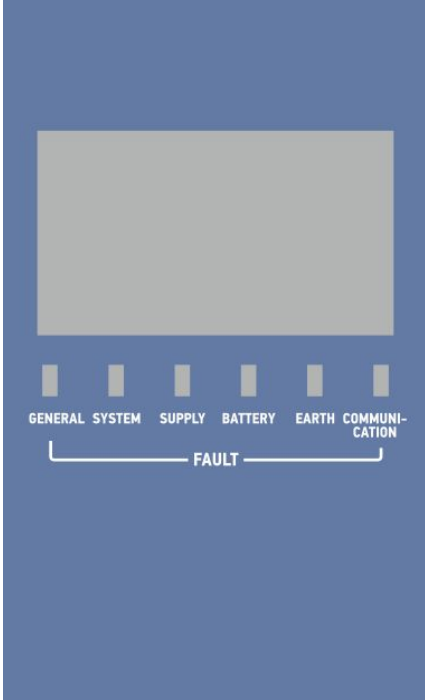
 <p>Figure 1-4. Indicators below the LCD screen</p>	<b>General Fault</b>	General fault of the panel
	<b>System Fault</b>	System fault
	<b>Supply Fault</b>	Power supply fault
	<b>Battery fault</b>	Battery fault
	<b>Earth fault</b>	Power Earth fault
	<b>Communication fault</b>	Communication fault

## 2 Functions

### 2.1 *Operation states of the panel*

Below we will describe in brief the indications on the screen for the following states of the panel:

#### A) Normal operation – quiescent state

#### B) Alarm state

#### C) Fault state

### 2.2 *Normal operation - quiescent state*

When there is no alarm or fault event the panel is in normal operation or quiescent state. The main screen has the following indications:



BS-1638	8-ZONES
SYSTEM READY	
STATUS,	NORMAL
0 DISABLED	
12:18	WE 16/01/14

**Figure 2-5. System in normal operation – quiescent state**

The first line shows how many zones the system has. It can be 8, 12 or 16 zones.

The last but one line shows the following messages in sequence:

- How many zones are «IN TEST»
- How many «FAULTS»
- How many sections are «DISABLED»

Only the POWER LED should be lit.

**Notice.** If there are any disabled sections then the corresponding LED will be lit and the screen will show «DISABLED»

### 2.3 Alarm State

When a device issues a fire alarm the red LED “**General Alarm**” is lit. The display will show information concerning the origin of the alarm as shown below:

3 - ALARMS	
FIRST : ZONE	1
FLOOR 2nd	
LAST: ZONE	6
WAREHOUSE	
0 DISABLED	
12:18	WE 16/01/14

Figure 2-6. Typical indication during an alarm

The first line shows how many alarms exist on the panel. The next line shows the first alarm that happened and specifically the zone and the name of the zone. The next line shows the last alarm that was issued with the corresponding information.

When an alarm is issued all the corresponding elements that are connected with the alarm will be activated. The built-in buzzer will start to sound intermittently. If we want to stop the buzzer we can press the key “**Buzzer Silence**” and if we want to stop the sirens we must go to the menu and press «**Siren Silence**».

Pressing the key “**VIEW ALARMS**” will show all existing alarms.

**2.4 Fault state**

In case of a fault state the yellow LED marked “**General Fault**” lights. Simultaneously other LEDs can be lit that describe the origin of the fault. The screen will show addition information regarding the fault.

BS-1638	8-ZONES
SYSTEM READY	
FAULT,	BATTERY
DISCONNECTED BATTERY	
2 FAULT	
13:18	WE 16/01/14

Figure 2-7. A typical screen during a fault state

The third section of the screen shows in sequence the faults of the system. The corresponding LED also lights to show the fault.

When a fault condition is encountered then the internal buzzer sound continuously and all the elements connected with the fault are activated. If we require we can stop the buzzer by pressing the key **“Buzzer Silence”**.

### 1.1 Access Level 1 functions

This access level contains the functions that can be set by a normal user

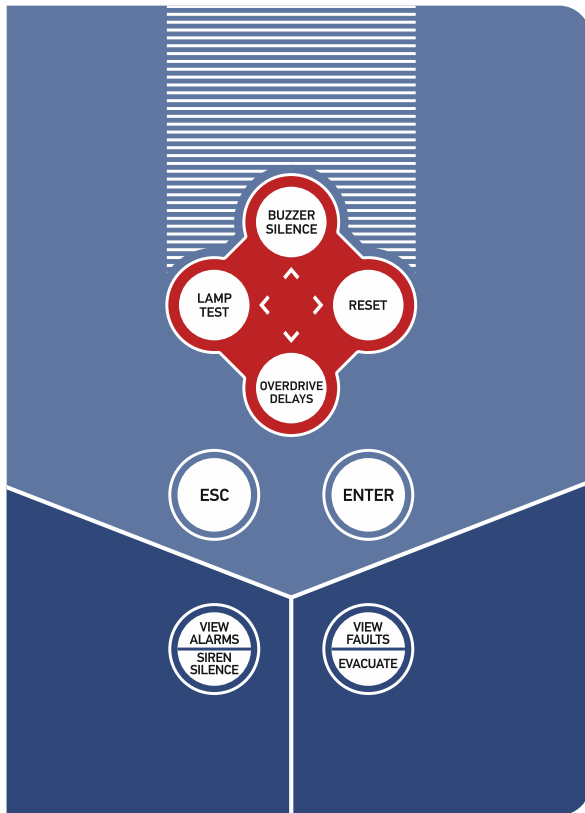

Figure 2-8. Access Level 1 Functions

- **“Buzzer Silence”**: In case of an alarm or fault, if this key is pressed then the internal buzzer stops. As long as the event exists the buzzer will sound once every 30 seconds. If during this state a new event happens then the buzzer will start to sound again.
- **“LAMP TEST”**: When the panel is in the normal-quiescent state then if we press this button the panel will light all the leds and the screen so we can verify the good operation.
- **“OVERDRIVE DELAYS”**: If an alarm event occurs and there are active delays, the user can override these delays by pressing this button. The output will be activated immediately.
- **“RESET (2sec press)”**: Resets the system, clears all current alarms, prealarms and faults.
- **“VIEW ALARMS”**: In case of an alarm event, if this key is pressed once, then we are presented with a menu from which we can see all the current alarms.
- **“VIEW FAULTS”**: In case of a fault event, if this key is pressed once then we are presented with a menu from which we can see all the current faults.
- **“SIREN SILENCE (2sec press)”**: In case of an alarm event, if this key is prolonged pressed then all the audible alarms are muted.
- **“EVACUATE (2sec press)”**: For evacuation, prolonged press the button and all alarm outputs will be activated.

## 1.2 Basic menu for Access Level 1

When the main screen is shown and we press the “ENTER” key then we are presented with the main selection menu. The screen shows the following.

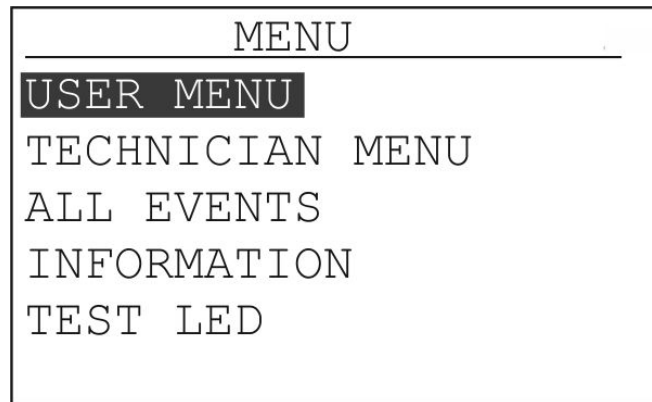

Figure 2-9. Main screen

As we can see, there are 7 basic functions in this menu as show in the diagram of figure 2-6.

The functions “CURRENT ALARMS” and “CURRENT FAULTS” are only shown when the panel has registered such events

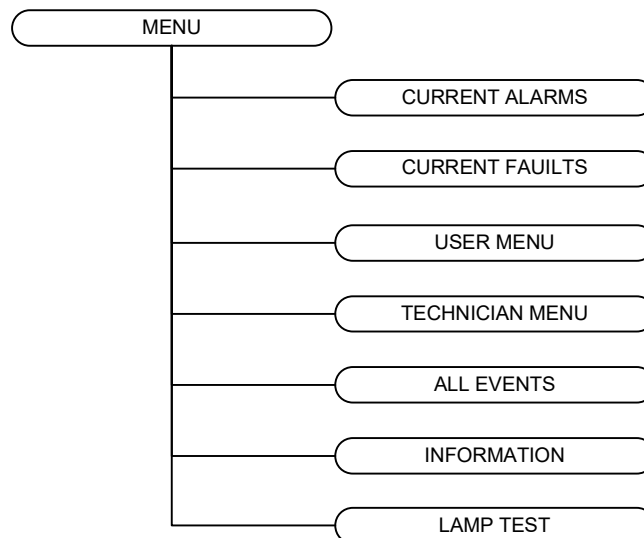

Figure 2-10. Menu diagram.

In detail:

- **CURRENT ALARMS** : This selection is shown only when the panel has registered an alarm event. Selecting this option will show in detail all the current alarm events.
- **CURRENT FAULTS** : This selection is shown only when the panel has registered a fault event. Selecting this option will show in detail all the current fault events.
- **USER MENU** : This menu contains all the functions that can be selected by a user that has access level 2 clearance.
- **TECHNICIAN MENU** : This selection can only be selected by the technician and contains the panels programming functions.
- **ALL EVENTS** : In this selection we can see all the events of the panel.
- **INFORMATION** : This selection contains information of the system that can be accessed by every user.
- **TEST LED** : All the indicators are lit. It is identical in operation as the «LAMP TEST» key.

To select a function use the «**UP**» and «**DOWN**» keys and then press «**ENTER**».

### 1.2.1 Events Menu

If we select the ALL EVENTS option and press the ENTER key then we will see the adjacent screen. The first screen shows information that was recorded and the second screen shown faults.

On all screens that contain information we can see a *i* on the top left corner. Next to this on the right we can see the source of the event (in our case GENERAL PANEL. Below this there is a detailed description of the event and then the time and date. The last line shows the current event number as well as the total events recorded.

On fault screens we can see an **X** on the top left corner. Next to this we can see the source of the fault (in our case Zone 6). The next line shows the name of the zone followed by the date and time. The last line shows the current fault number as well as the total number of recorder faults.

With the up and down keys we can scroll through all the events. Pressing the ESC key will takes us back to the previous menu.

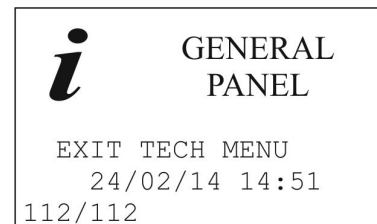

Figure 2-11. Events Menu

### 1.2.2 Test Led

If we select TEST LED and press ENTER we will see the adjacent screen. All the LEDs will be lit so we can verify the good operation. Press ESC to go to the previous menu.

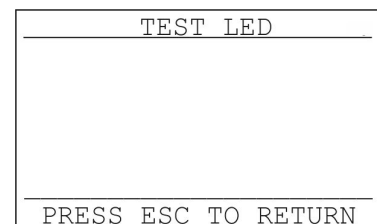

Figure 2-12. LED test

### 1.3 Information

By selecting the INFORMATION option we can see the following screen. Some option can't be seen in the initial screen and we must use the up and down keys to scroll to them.

INFORMATION	INFORMATION
PANEL ▲	NETWORK ▲
ALARMS COUNTER	TECHNICIAN INFO
SHOW DISABLED	PANEL SOFT VERSION
ZONES	
AUX RELAY	
SIRENS ▼	

Figure 2-13. Information menu

If we select PANEL we can see information regarding the power supply and the battery.

PANEL	
MAINS	OK
CHARGER	26.6 VDC
BATTERY	25.9 VDC
24VDC	22.9 VDC
PRESS ESC TO RETURN	

The ALARMS COUNTER option shows an alarm count which is according to EN 54-2.

ALARMS COUNTER	
26	
PRESS ESC TO RETURN	

You can see disabled section by selecting the option SHOW DISABLED. Use the UP and DOWN keys to show all disabled sections.

i	GENERAL
	ZONE 4
	FLOOR 1
	DISABLE
	24/02/14 14:51
	1/4 DISABLED

By selecting the AUX RELAY option we are presented will the following menu.

AUX RELAY	
LOGIC AND-CROSS ZONE	
LOGIC OR	
PREDELAY	

The option «SIRENS» reveals the setting of the 2 sirens.

```

SIRENS
-----
SIREN 1 : ENABLE
NO PREDELAY
-----
SIREN 2 : ENABLE
NO PREDELAY
-----
PRESS ESC TO RETURN
  
```

If we select NETWORK and press ENTER we can see the adjacent screen. This screen shows if the Ethernet card is installed. If it is installed then we can see its IP and MAC address. Press the ESC key to return to the INFORMATION MENU.

```

NETWORK
-----
ETHERNET PCB YES

IP = 010.020.030.040

MAC 54:55:58:10:03:EF
PRESS ESC TO RETURN
  
```

By selecting the TECHNICIAN INFO we can see the adjacent screen. By default we see that the technician information has Olympia electronics, the phone number and the installed site name. This information can be changed by using a P/C.

Press ESC to return to the INFORMATION menu.

```

TECHNICIAN INFO
-----
OLYMPIA ELECTRONICS
00302353051200
BUILDING CBS
-----
PRESS ESC TO RETURN
  
```

If we select PANEL SOFT VERSION we can see the installed panel firmware version.

Press ESC to return to the INFORMATION menu.

```

BS-1638
VER.01.02-MU
-----
PRESS ESC TO RETURN
  
```

### 1.3.1 Zone Information

In the zones information menu we can see the following options:

ZONES	ZONES
ZONES INSTALLED ▲	FAULTS IN TEST ZONES▲
ZONES IN ALARM	
ZONES IN FAULT	
DISABLED ZONES	
ZONES IN TEST	
ALARMS IN TEST ZONES▼	

Figure 2-14. Zone information.

 <b>olympia™ electronics</b> <small>SAFETY &amp; SECURITY SYSTEMS</small> <i>for a safer world!</i>	Date	10/6/2022
	File	
	Document code	921163800_09_008
	Page	16 from 47

In the option ZONES INSTALLED we can see how many zones are installed in the panel. E.g. BS-1638 has 8 zones, BS-1642 has 12 zones.

INSTALLED ZONES							
01	02	03	04	05	06	07	08
09	10	11	12				

In the selections «ZONES IN ALARM» and «ZONES IN FAULT» we can see which zones have an alarm and which have a fault respectively. The number of the zone blinks.

ZONES IN ALARM	
02	08
09	

Finally, the last three options we can see which zones are in test mode, which are in test mode and have an alarm and which are in test mode and have a fault.



## 2 User Menu

In this section we will refer to the selection that can be done by a user (access level 2).  
 To enter the menu of the panel press **«ENTER»** and the display will show (figure 3-1).

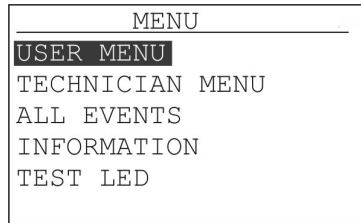

Figure 2-15. Main menu

Next select the **«USER MENU»** option with the use of the keys **«DOWN»** and **«UP»**.

To enter access level 2 a code is required.

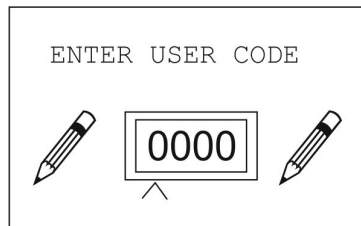

Figure 2-16. User code

Enter the user code using the up and down keys to change the value of the digit. Use the left and right keys to move to the next or previous digit. When the code has been entered press the ENTER key to accept.

The factory default code is **«1111»**.

Figure 3-3 shows the tree diagram of this menu.

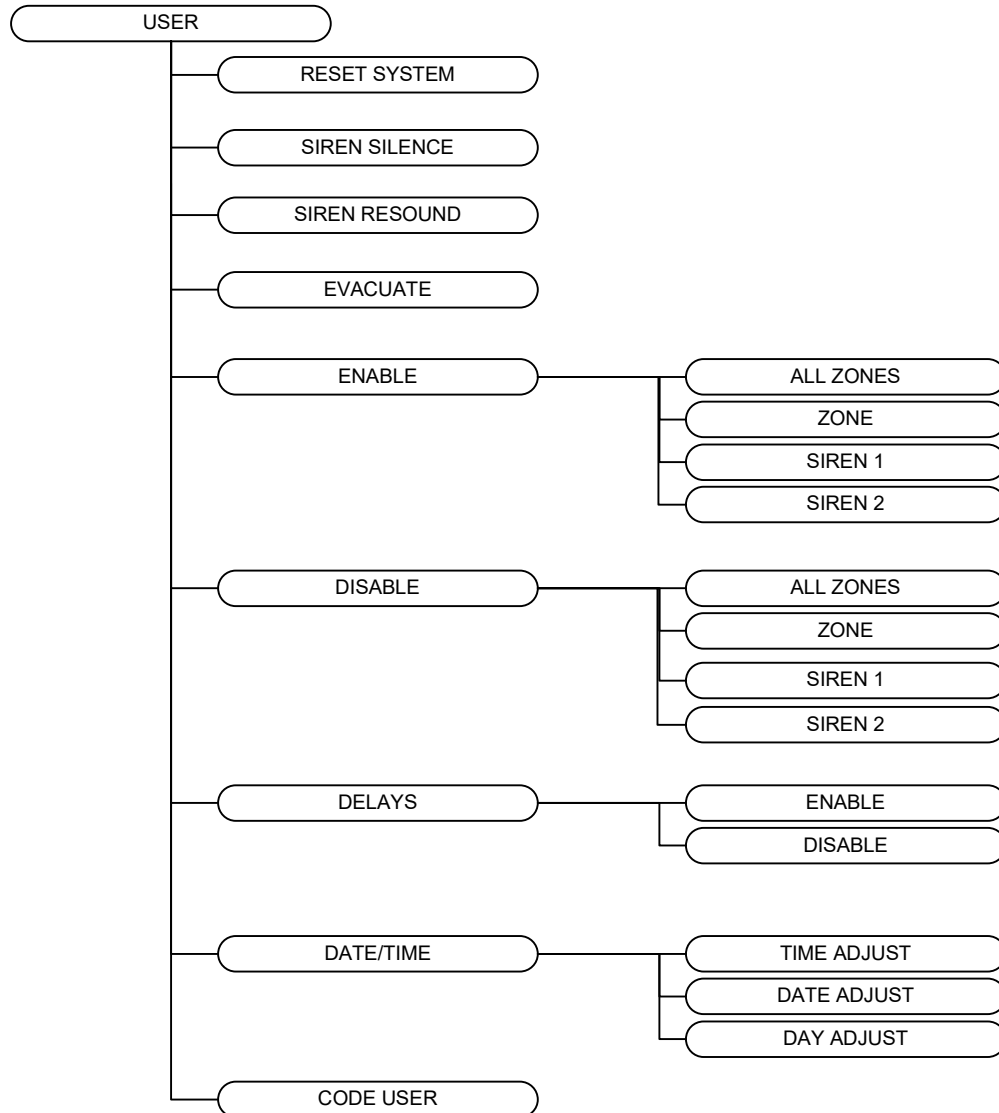

Figure 2-17. User menu tree diagram

In this menu we can do the following basic functions.

- **RESET** of the system.
- **SIREN SILENCE** in case of an alarm.
- **SIREN RESOUND** in case of an alarm and if the sirens have been silenced.
- **EVACUATE** for the system to enter alarm mode.

## 2.1 Enable – Disable menu

With the selection ENABLE we can activate any element of the panel as shown in figure 3-4.

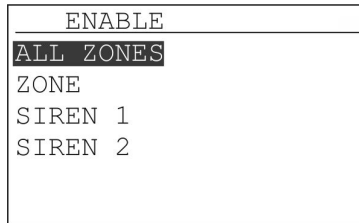

Figure 2-18. Activate menu

We have the following selections:

- **ALL ZONES** : All elements of the panel are activated.
- **ZONE** : We select the zone that we want to activate (1 – 16 depending on the panel), with the keys «UP» and «DOWN».
- **SIREN 1 and SIREN 2**: We can select which siren we want to activate.

Respectively in the «DISABLE», menu we have the same options but now we can deactivate the elements.

## 2.2 Delay menu

Using this menu the user can activate or deactivate the time delays.

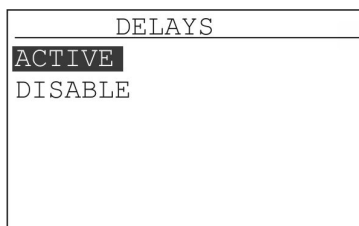



Figure 2-19. Delays menu

## 2.3 Adjusting the time and date

The user in this menu has the capability to adjust the following:

- **ADJUST DAY** : Set the day of the week.
- **ADJUST DATE** : Set the date.
- **ADJUST HOUR** : Set the hour.

  <p><i>for a safer world!</i></p>	Date	10/6/2022
	File	
	Document code	921163800_09_008
	Page	20 from 47

The first 3 options are used to adjust the hour, date and day in a simple manner. To change the values use the navigation keys, UP, DOWN, LEFT, RIGHT. After selecting each value press the «ENTER» key.

With the next 3 options we adjust the date and hour. It is critical to adjust these settings during the initial installation because all events are recorded using this time and date.

By selecting DAY OF WEEK SETTING and Enter we see the adjacent screen. Select the required day and press Enter.

CHANGE DAY OF WEEK

SUNDAY ▲

MONDAY

TUESDAY

WEDNESDAY

THURSDAY

FRIDAY ▼

By selecting DATE SETTING and Enter we see the adjacent screen. Use the up and down keys to change the value and the right, left keys to go to the next or previous digits. After the desired date is entered press the ENTER key.

CHANGE DATE

24 / 02 / 14

^

By selecting TIME SETTING and Enter we can see the adjacent screen. Use the up and down keys to change the value and the right, left keys to go to the next or previous digits. After the desired time is entered press the ENTER key.

CHANGE TIME

14 : 52

^

## 2.4 Changing the user code

The last option permits the user to change the user code. Use the up and down keys to change the value and the right, left keys to go to the next or previous digits. After the desired code is entered press the ENTER key.

## 2.5 Use a P/C to access the user menu

The programming of the panel can be done using the panels own keyboard or by using a personal computer. If we have a network of panels then some options can only be done using a computer.

### 2.5.1 Using a personal computer

To program the panel using the P/C no special software is required. A common web browser (Chrome, Firefox, Internet Explorer κ.λ.π), can be used. We suggest Google Chrome. The following screens are from Google Chrome. Prerequisites are that the panels must have an Ethernet card installed, we must know the IP address of the panel, the P/C must be connected to the same network as the panel and the network setting of the P/C must be correct. With suitable settings we can have access to the panel via internet from what every part of the world we require. All these settings must be adjusted by the network manager of the building.

Our first action is to open a web browser and in the URL address line we must enter the IP address of the panel. If all is connected correctly then we will see the following screen.

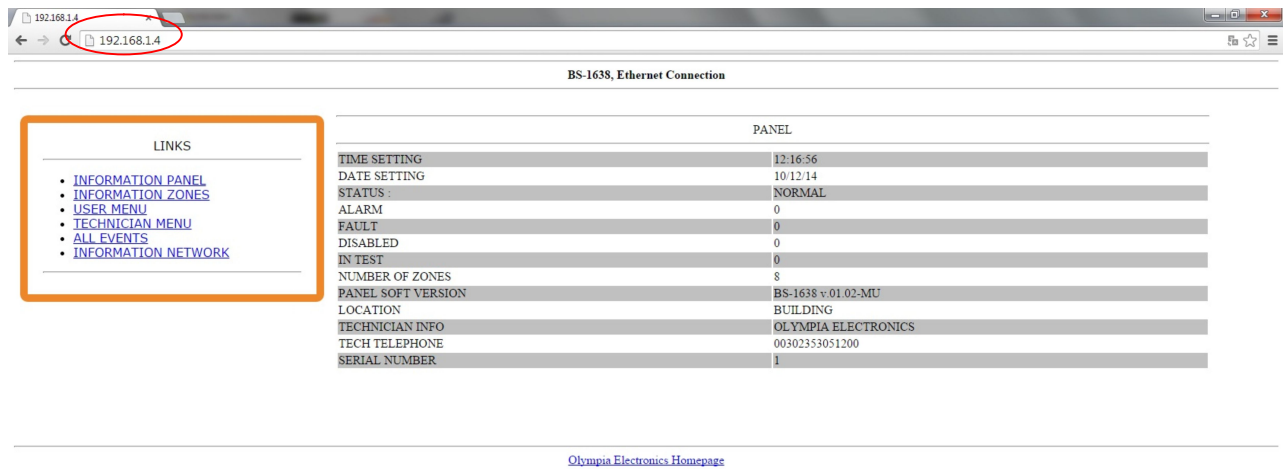

LINKS		PANEL	
• <a href="#">INFORMATION PANEL</a>	TIME SETTING	12:16:56	
• <a href="#">INFORMATION ZONES</a>	DATE SETTING	10/12/14	
• <a href="#">USER MENU</a>	STATUS	NORMAL	
• <a href="#">TECHNICIAN MENU</a>	ALARM	0	
• <a href="#">ALL EVENTS</a>	FAULT	0	
• <a href="#">INFORMATION NETWORK</a>	DISABLED	0	
	IN TEST	0	
	NUMBER OF ZONES	8	
	PANEL SOFT VERSION	BS-1638 v.01.02-MU	
	LOCATION	BUILDING	
	TECHNICIAN INFO	OLYMPIA ELECTRONICS	
	TECH TELEPHONE	00302353051200	
	SERIAL NUMBER	1	

[Olympia Electronics Homepage](#)

The pre-installed IP is 10.0.1.149.

On the right we can see information of the system and its operation state.

All the functions in the section "LINKS" on the left are available to the user. The TECHNICIAN MENU is not available.



for a safer world!

Date	10/6/2022
File	
Document code	921163800_09_008
Page	22 from 47

### 2.5.2 Panel information

By selecting «INFORMATION PANEL» we can see the screen below which shows the state of the panel, information about the sirens and the auxiliary relay.

PANEL	
TIME SETTING	12:33:22
DATE SETTING	10/12/14
MAINS VOLTAGE :	OK
CHARGER VOLTAGE :	26.4 VDC
BATTERY VOLTAGE :	26.3 VDC
SIREN 1	ENABLE
SIREN 1 DELAY	NO PREDELAY
SIREN 1 STATUS :	NO ACTIVE, NORMAL
SIREN 2	ENABLE
SIREN 2 DELAY	NO PREDELAY
SIREN 2 STATUS :	NO ACTIVE, NORMAL
ALARMS COUNTER	0
AUX RELAY LOGIC AND-CROSS ZONE	
AUX RELAY LOGIC OR	
AUX RELAY DELAY	NO PREDELAY

### 2.5.3 Zone Information

This screen shows how each zone has been programmed to operate.

ZONES						
ZONES	INSTALLED	NAME	DISABLED	STATUS :	TEST	TEST STATUS :
1	YES	ZONE 1	NO	NORMAL	NO	
2	YES	ZONE 2	NO	NORMAL	NO	
3	YES	ZONE 3	NO	NORMAL	NO	
4	YES	ZONE 4	NO	NORMAL	NO	
5	YES	ZONE 5	NO	NORMAL	NO	
6	YES	ZONE 6	NO	NORMAL	NO	
7	YES	ZONE 7	NO	NORMAL	NO	
8	YES	ZONE 8	NO	NORMAL	NO	

	Date	10/6/2022
	File	
	Document code	921163800_09_008
	Page	23 from 47

### 2.5.4 All events

The selection shows the events of the system in chronological succession.

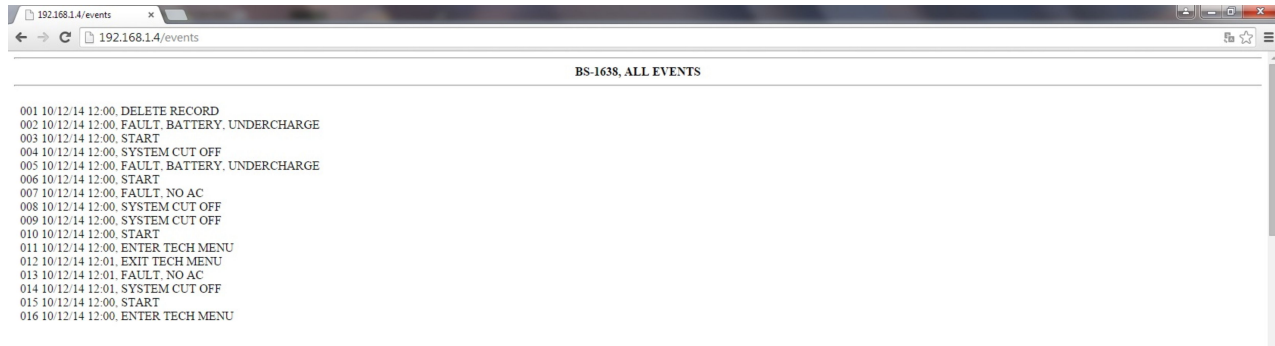

### 2.5.5 Network Information

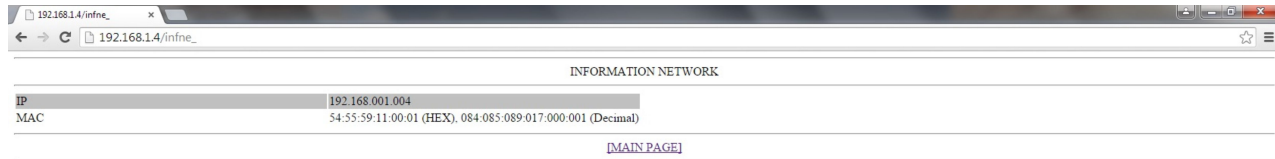

We can see the IP and MAC address of the panel

### 2.5.6 User Menu

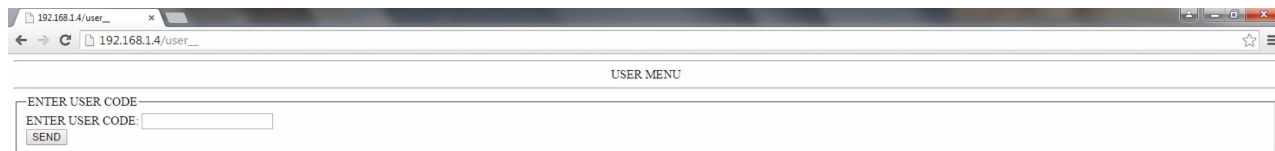

By selecting USER MENU we see:



Place the cursors in the field “USER CODE”, enter the user code and press SEND. If the code is correct the user menu is shown.



Its operation and functions are identical as in the panel.

  <p><i>for a safer world!</i></p>	Date	10/6/2022
	File	
	Document code	921163800_09_008
	Page	24 from 47

### 3 Installation

This section contains information that regards the design of the installation, the connection of the panel with its peripherals and all the auxiliary inputs and outputs. The complete knowledge of the panel's capabilities and its peripheral devices is required for a good installation.

**All connection described below must be done with the mains power supply isolated and the battery cables disconnected.**

#### 3.1 Safety

**A device cannot be considered that it is used correctly if you do not read the accompanying documents that are supplied.**

This product must be installed, commissioned and serviced only by **qualified and trained personnel** according to:

- The regulations concerning the installation of electrical device in a building.
- The fire safety regulations.
- The instructions of the manufacturer.

- The product operates with a voltage of 220-240V AC/50-60Hz and is a class 1 unit. (For safety and operation reasons it requires that the power earth cable of the building is connected).

- It must be installed to the current electrical installation using a dedicated fuse with a label **«Fire detections system – Do not close the switch»**.

#### 3.2 Installation

The installation of the panel must be done only by qualified personnel only.

Prior to any maintenance procedures isolate the mains power supply from the panel.

Do not remove or install boards with the mains power active.

During the installation use an anti-static protection wristband to protect the panel from electrostatic discharge (ESD).

The panel must be permanently mounted.



### 3.2.1 Mounting the panel on the wall

The packaging contains: The panel, the mounting accessories and the user manual.

The package also contains the keys for the front cover lid lock.

The panel must be mounted on a dry and clean sturdy wall that is free from vibrations and shocks.

The image below shows the mounting holes of the panel.

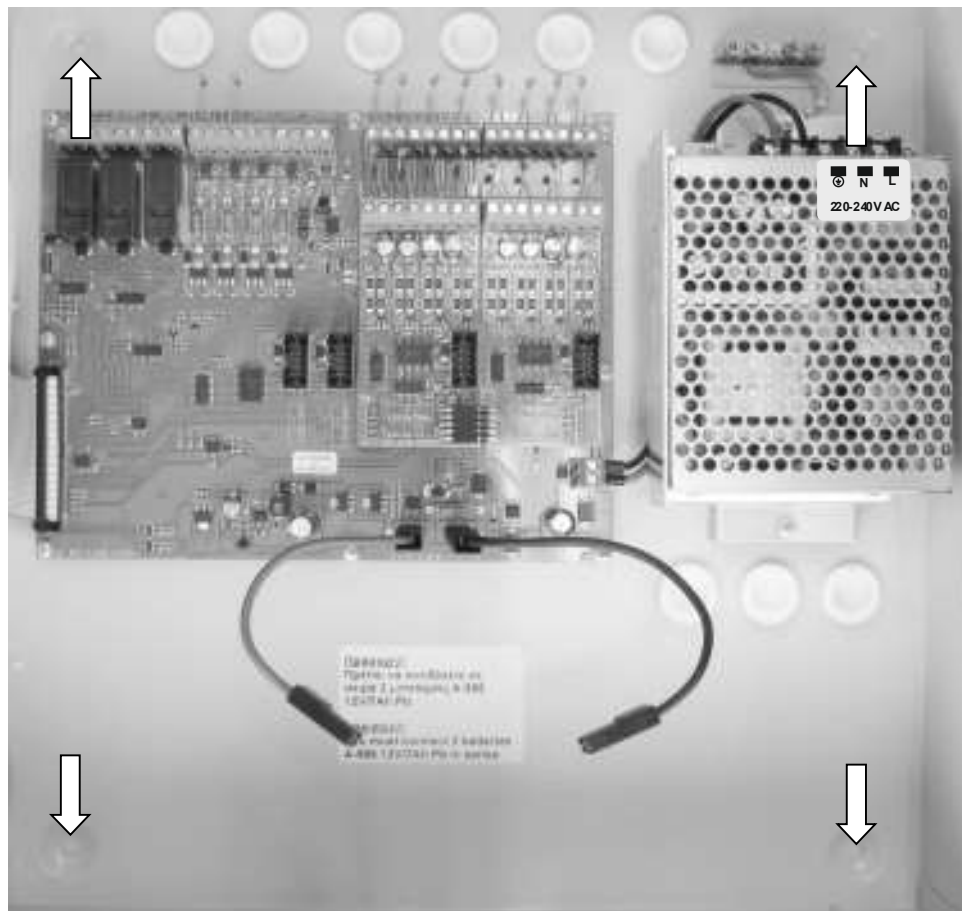

**Figure 3-20. Mounting hole locations.**

The panel must be mounted at least 1m from floor level and at least 1m from the ceiling and about 30cm from surrounding objects. No other power lines should pass behind the panel apart from its own. Mounting the panel to the wall it done via the 4 mountings holes and by using the provided mounting accessories.

The panel should be mounted in a clearly visible and accessible site that can be easily accessed by the person responsible for the fire detection system. The panel is suitable for wall mounting installations in interior areas.



for a safer world!

Date 10/6/2022

File

Document code 921163800\_09\_008

Page 26 from 47

### 3.3 Cables

In order to comply with electromagnetic compatibility (EMC), the connection to the panel must be done with shielded cable.

Each shield of the cable must be connected normally to the earth cable in order to assure the smallest route.

The maximum cross section of the cable is 2,5mm<sup>2</sup>.

The panel has numerous cable entry point located on the top and the rear. (see. figure 3.4).

The rubber grommets must not be removed in order to preserve the IP30 cover protection rating. (required by the norm EN 54-2).

Each connection must have its own cable. For the connection of the zone or the siren a two core cable is required whereas for the connection of the 230V power supply a three core cable is required.

All isolations and earths from the cables must be connected to the terminal connectors found on the left of the panel.

**The connection cables must be certified for fire detections installations.** Such cables are FIP200, MICC, PYROFIL.

The cables used for data must be twisted pair with and external shield.

The terminal block of the product can accept **cables with a diameter up to 2.5mm**. All terminal must be tight even if they do not have a connection.

The diameter of the cable for conventional sirens is shown on the table below.

**Table 3-1 Cable length for sirens (Alarm)**

Cable length (m)	200m	500m	1000m	1500m	2000m
Alarm Current consumption(mA)					
100mA	<b>1.0 mm<sup>2</sup></b>	<b>1.0 mm<sup>2</sup></b>	<b>2.0 mm<sup>2</sup></b>	<b>2.5 mm<sup>2</sup></b>	<b>2.5 mm<sup>2</sup></b>
250mA	<b>1.0 mm<sup>2</sup></b>	<b>1.5 mm<sup>2</sup></b>	<b>2.5 mm<sup>2</sup></b>	<b>2.5 mm<sup>2</sup></b>	<b>2.5 mm<sup>2</sup></b>
300mA	<b>1.5 mm<sup>2</sup></b>	<b>1.5 mm<sup>2</sup></b>	<b>2.5 mm<sup>2</sup></b>	<b>2.5 mm<sup>2</sup></b>	<b>2.5 mm<sup>2</sup></b>

The main power connection of the panel must be connected to the main power supply using a separate fuse with the marking «**Fire Detection System – Do not close the switch**». The fuse rating must be 16A.

The central power connection must have an earth cable that is connected to the main power earth connection of the building.

### 3.4 Describing the interior of the panel

To access the interior of the panel we must open the lock on the front lid.

**The BS-1638 panel main consists of two sections:**

1. The left section which is the lid and contains the main pcb with the controller, the indication pcbs and the lock.
2. The right section contains the power supply, the zone and input/output pcbs, the battery compartment and the cable entry holes.

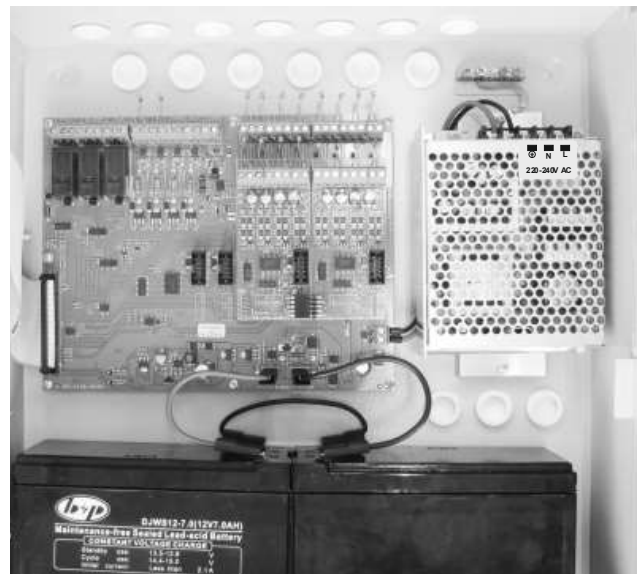
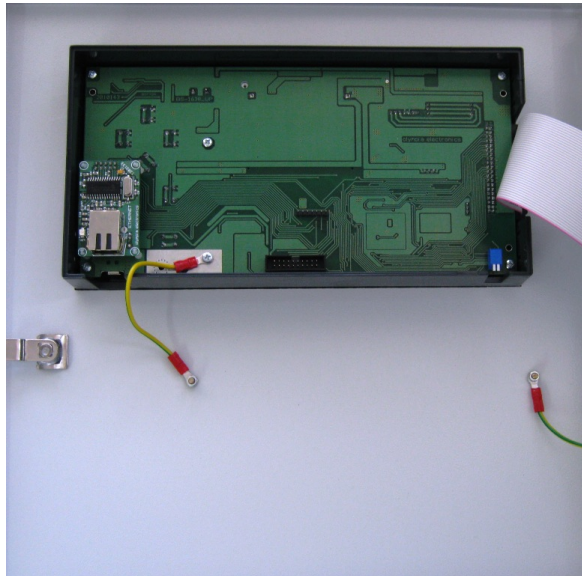

Figure 3-21. Panel Interior

### 3.5 Connecting the power supply cables (220-240V AC)

The panel has cable entry holes for all the cables. You can connect cables with a maximum diameter of 2.5mm to the terminal blocks.

The power supply cables of the panel must be with double insulation. The power supply cable must also contain a power earth cable that must be connected to the main power earth connection of the building.

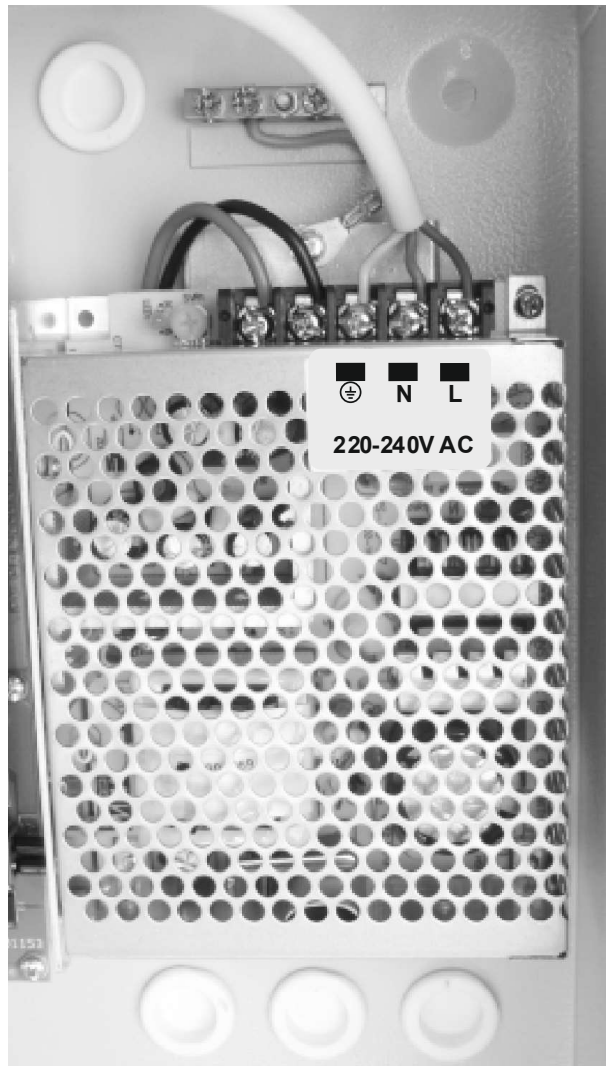

Figure 3-22. Connecting the 230VAC

**Warning.**

1. Each installation and maintenance procedure must be done with the mains power supply isolated.
2. During the installation, the connection of the batteries and the power supply must be done after completing the other connections.
3. The connection with the power supply must be done using a dedicated fuse with a rating of 16A.
4. Always use double insulated cables for the mains power supply.
5. The external cable diameter must be at least 1cm.
6. The external insulation of the cable must not be removed more than 1cm.
7. The external insulation must not be removed more the 1cm from the edge of the internal insulation.
8. The internal fuse rating of the panel is F 4A 250V of the type TR5.
9. The battery fuse is 900mA and is self resetting.



Date	10/6/2022
File	
Document code	921163800_09_008
Page	29 from 47

### 3.6 Connecting the batteries.

The panel has space with suitable dimensions for installing batteries of the type A-986 from olympia electronics. The charging circuit has been adjusted for these specific batteries. Should the batteries need replacing, replace them with the same type and rating.

The batteries should be connected in series. The battery compartment contain two cables, one red and one black, which are connected to the panel and one more cable that is not connected. These cables must be connected in a specific order. The red cable must be connected to the positive contact (+ RED) of the first battery. The black cable should be connected to the negative contact (- BLACK) of the second battery. The third cable is used to connect the negative contact (- BLACK) of the first battery to the positive contact (+ RED) of the second battery.

This connection is shown in the diagram below.

**The batteries used should be 2x A-986 12V (7Ah) lead acid type with a voltage of 12V.** There capacity must be 7Ah or 9Ah (A-961).

**Battery Recycling.** It is not allowed to dispose batteries in common waste bins. They should be disposed only in special battery recycling collection points.

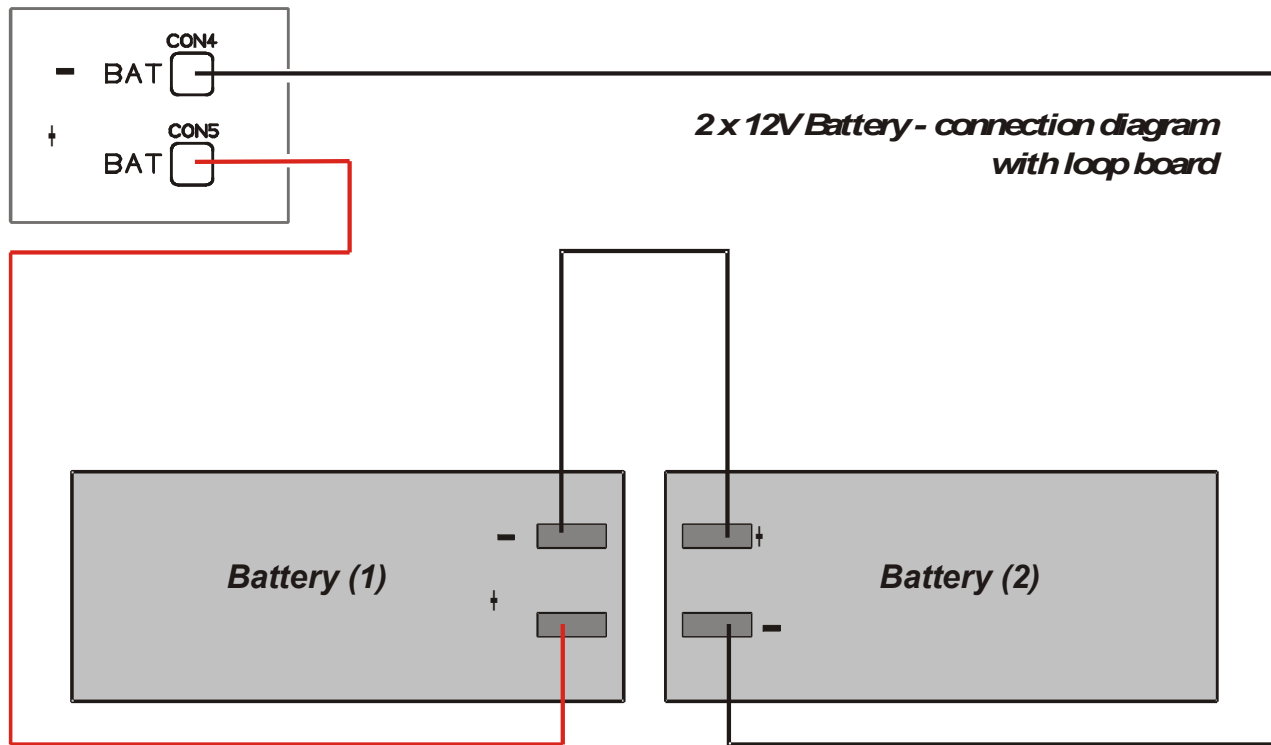

Figure 3-23. Connecting the batteries in series.



Date	10/6/2022
File	
Document code	921163800_09_008
Page	30 from 47

### 3.7 Connecting the Zones

The panels of this family have the same connections. The only difference they have is the number of the zones and the zone relays. The common outputs, the maximum consumptions and the connection diagrams that will be mentioned below are common to all the panels.

By default, the terminal block of each zone contains a (8K2) terminal resistor. The resistor must be removed from the terminal block and installed on the last device of the zone or left connected on the zones terminal block if the zone is not used.

The connections of all the zones are identical. What is shown on the next 3 diagrams for zone 1 is also valid for the other zones.

Up to 20 devices (maximum) can be connected on each zone.

The shield of the cable that is used in the installation must be connected to the ground in order to conform to the requirements of the electromagnetic compatibility norm (EMC).

The length of the cable must not exceed 2 km and the maximum diameter should not be more than 2mm<sup>2</sup>.

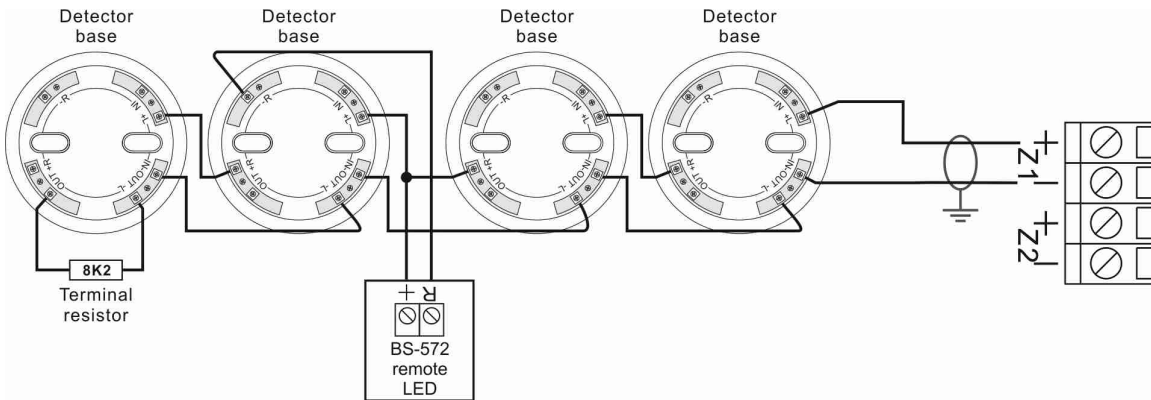

Figure 3-24. Connecting 4 detector bases to zone 1. On each base you can install BS-655, BS-660 or BS-657 detectors. On one detector there is a BS-572 detector LED connected.

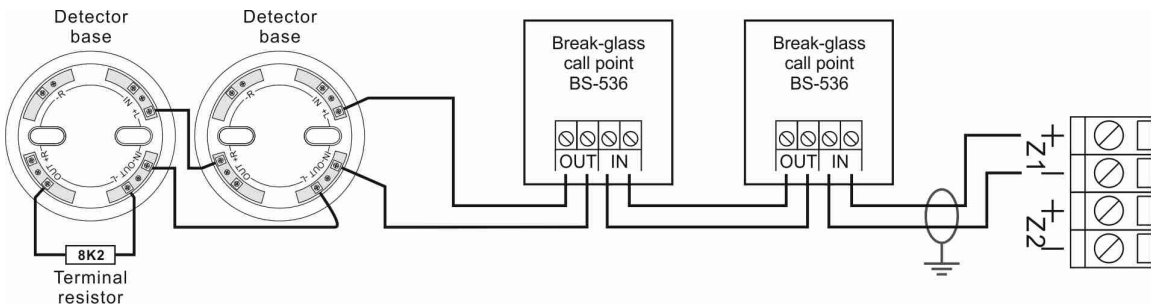
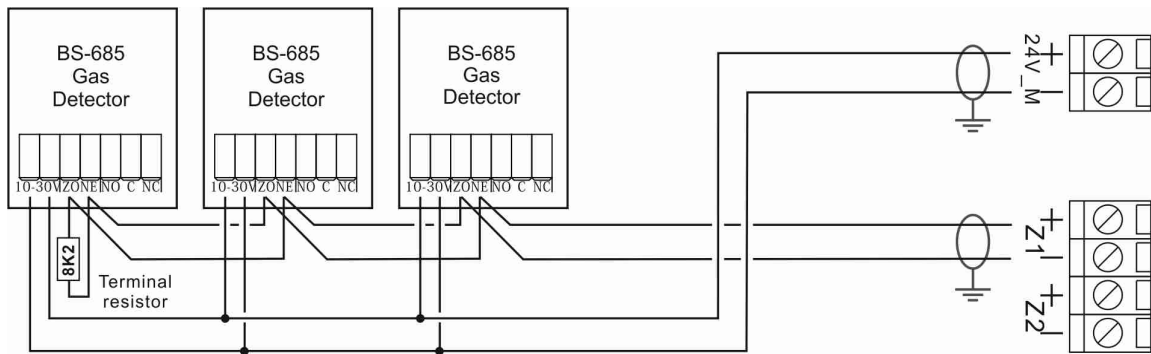
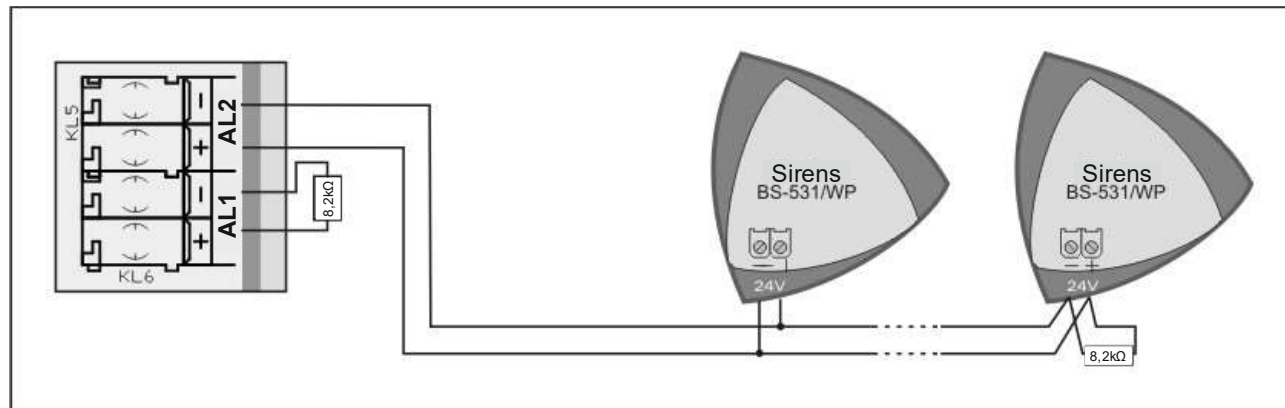

Figure 3-25. Connecting 2 detector bases and 2 BS-536 call points to zone 1. On each base you can install BS-655, BS-660 or BS-657 detectors.



**Figure 3-26. Connecting 3 gas detectors BS-685 or BS-686. Apart from connecting the detectors to the zones, the detectors must also be powered from the terminals 24V\_M.**

### 3.8 Connecting the Sirens



**Figure 3-27. Connecting the sirens to the panel**

The panel contains 2 outputs that are used for connecting the sirens. These outputs are marked as «AL1» and «AL2». Each output can provide up to 300mA and is monitored for open and short circuit conditions. By default these terminals have an 8,2K $\Omega$  terminal resistor installed. If an output is not used then the resistor must be left installed on the terminal. If the output is used then the terminal resistor is removed and installed in parallel with the last siren.

By default both of these outputs are programmed to operate in case of an alarm condition.

On these outputs we can connect all the conventional sirens, bells or fire detection beacons (BS-530, BS-531, BS-530/WP, BS-525).

The connections of both circuits are identical.

#### 4.9 Connection to a network panels

It is possible to connect the panels to a network. Each panel in the network must have its own address. The central panel has address 1 and the sub-panels from 2 to 16. The figure below shows the connection between them.

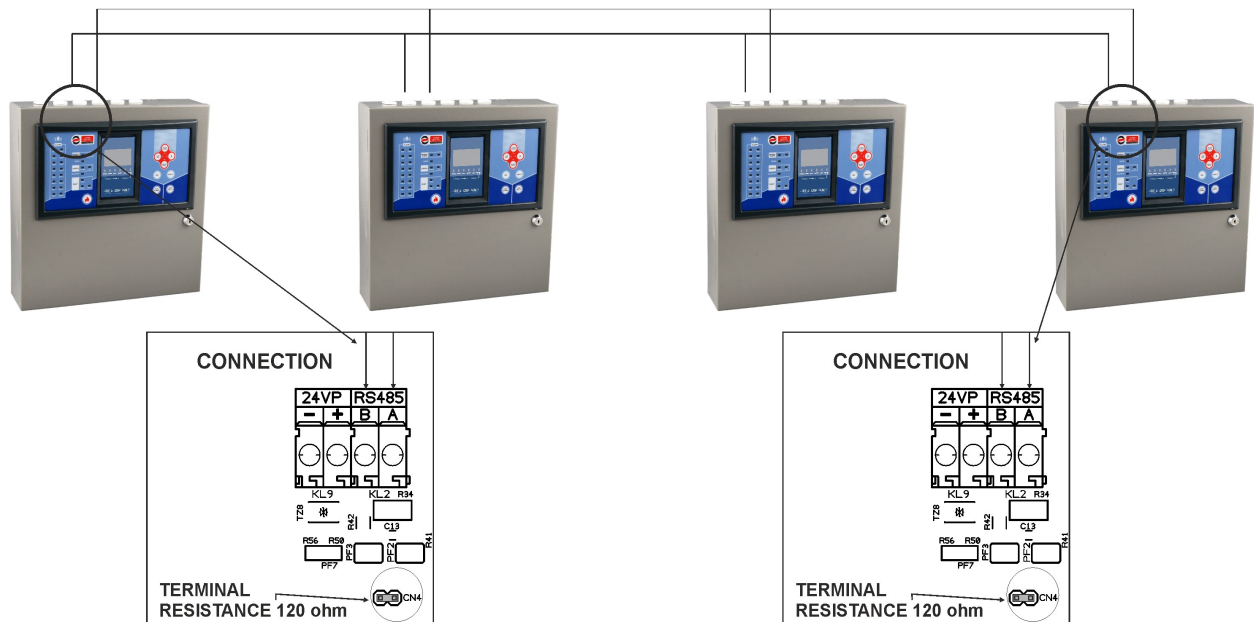

*The interface cable is bipolar twisted. The connection topology is parallel so the cable should be passed from one panel to another and there must not be any branches.*

**They can be connected up 16 panels on a network.**

RS-485 is the communication protocol between the panels.

**ATTENTION!** Resistors 120Ohm/0.5W should be placed at the beginning and the end of the cable. The total cable length should not exceed 500m. For longer distances a RS-485 repeater should be used.

**The cable shield must be connected to the grounding of the panel.**

During the installation all sub-panels must first be addressed and then a search of the network must be conducted from the central panel.



  <p><i>for a safer world!</i></p>	Date	10/6/2022
	File	
	Document code	921163800_09_008
	Page	33 from 47

#### 4.10 Other Connections

The following paragraphs mention all the connections that can be achieved with the panel.

**Every connection must use a separate cable** (e.i. a triple cable for connecting the panel to the 230VAC mains power supply, a double cable for the sirens e.t.c.).

**The shield of each cable must be connected to the main ground terminals of the panel**

The zone and input-output PCB contains the following outputs:

- **24V\_M:** A 24V dc output (up to 300mA) that is interrupted during a reset of the panel. It is used to power gas detectors or other devices that need the power interrupted during a panel reset.
- **24V\_P:** A 24V dc output (up to 300mA) that is not interrupted during a panel reset. It can be used to power electromagnetic door latches.
- **Relay Alarm :** Voltage free relays contacts that are activated during an alarm.
- **Relay Fault :** Voltage free relays contacts that are activated during a fault.
- **Relay AUX :** Voltage free relays contacts that are programmable from the panel.  
WARNING: The maximum rating of the relays is 30VDC and 3A.
- **Relay per Zone :** The panel has outputs to connect up to 4 BS-615 (4 zone expansion card with relays). For example, if we want the relay of zone 3 we must connect a BS-615 to the connector Flat cable 1. The photo below shows which relay belongs to which zone.

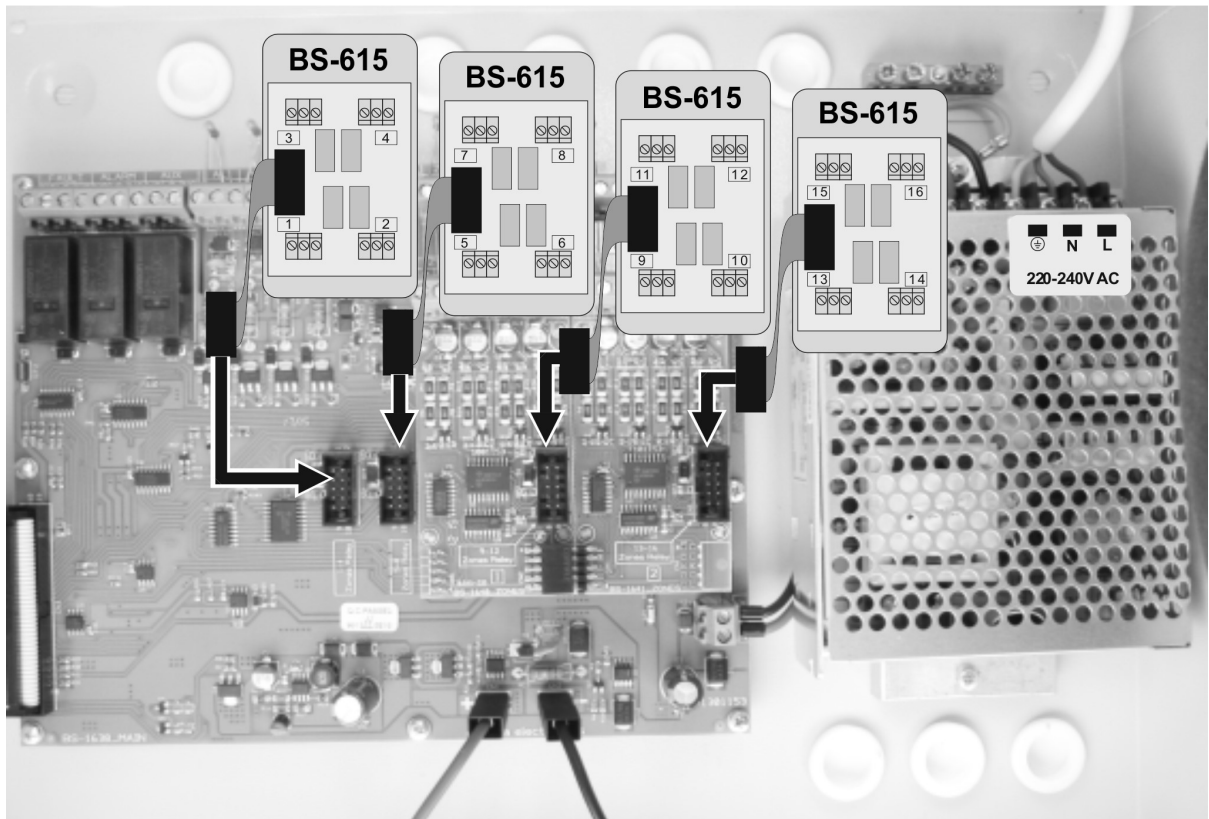
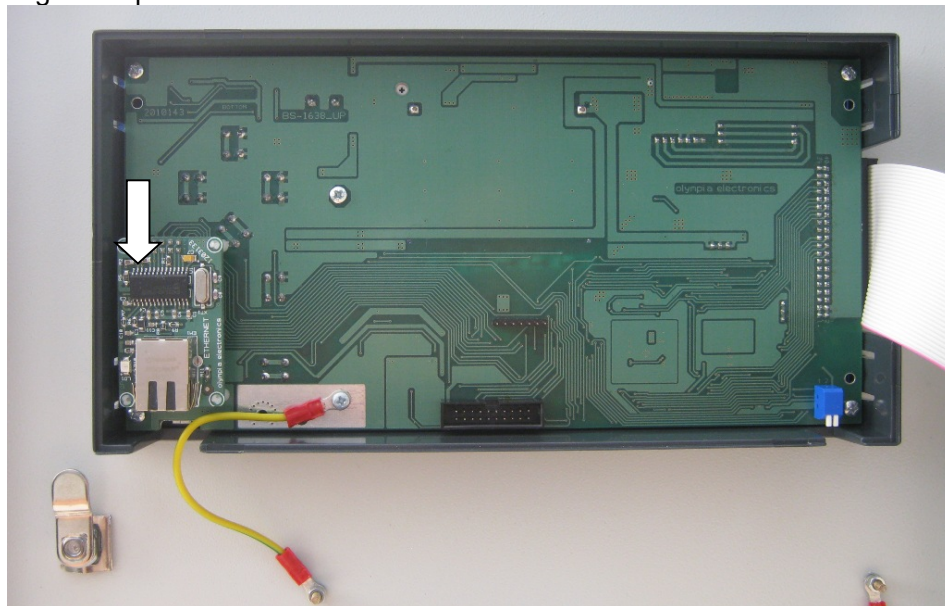

Figure 3-28. Relay per BS-615 installation

- **Ethernet:** To connect the panel to a local network use an ETHERNET cable type RJ45. The ETHERNET card can be bought separately if it is not installed. During the installation of the card the panel must not be operating and it must be installed according to the photo below.



  <p>for a safer world!</p>	Date	10/6/2022
	File	
	Document code	921163800_09_008
	Page	35 from 47

Figure 3-29. Installing an Ethernet card

## 4 Technician Menu

This section will cover all the options that are available in the Technicians Menu ( access level 3 and 4). To enter the main menu of the panel press **«ENTER»** while in the initial screen.

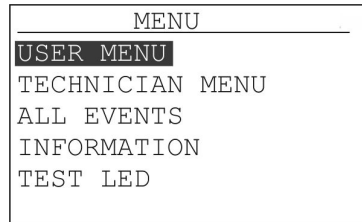

Figure 4-30. Main Menu

Next select **«TECHNICIAN MENU»** and press **«ENTER»**.

A code is required to enter access level 3.

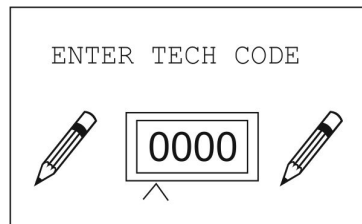

Figure 4-31. Technician code

To select the code use the keys up, down, to increase the value of the digit and the keys right-left to change digits. After entering the complete code press Enter.

The factory default code is **«2333»**.

Figure 5-3 shows the tree detail of this menu.

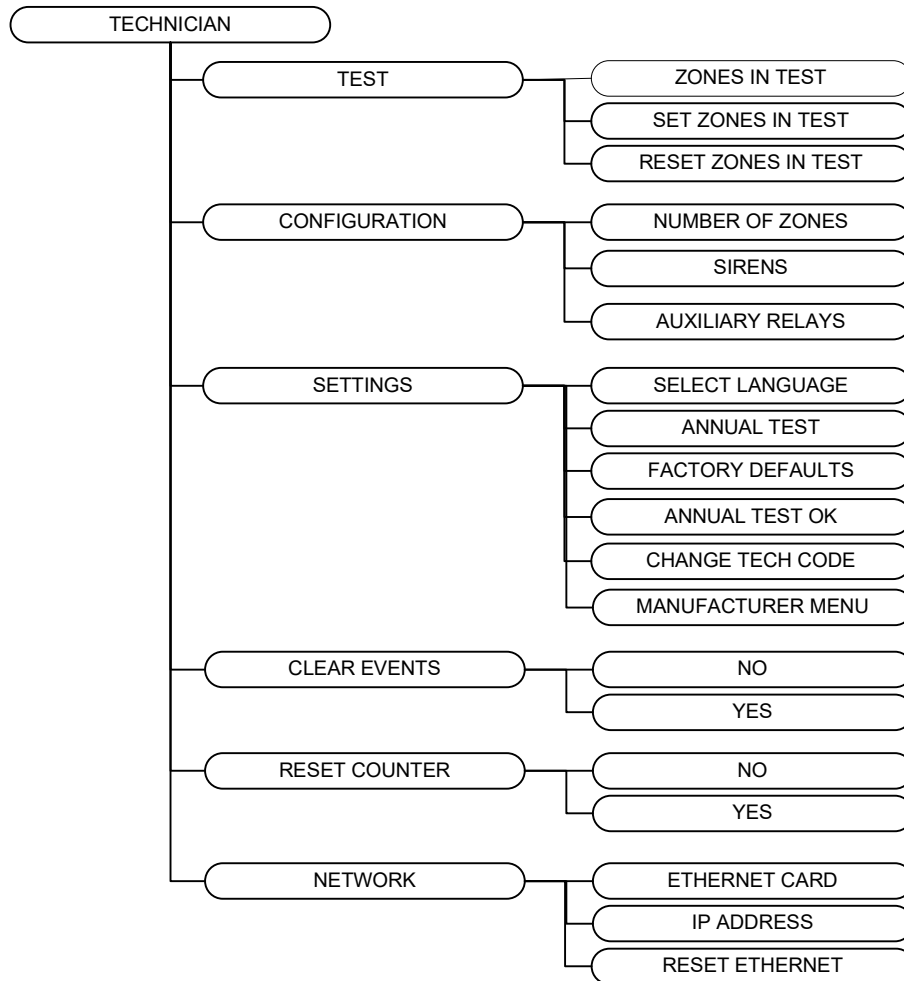

Figure 4-32. Technician menu

Next there will be a detailed description of each option.

#### 4.1 Test menu

In this option we can adjust the state of each zone during the test. The setting is done using the option «ZONES IN TEST» where we can select which zone will be on test.

After adjusting this we can test the zones without affecting the outputs of the panel. The state of the zones in test can be found in the option INFORMATION→ZONES→ ZONES IN TEST, ALARMS IN TEST ZONES and FAULTS IN TEST ZONES.

To reset the zones to normal operation use the option «UNSET ZONE IN TEST».

## 4.2 Setup menu

In this submenu basic elements of the panel are adjusted.

### 4.2.1 Number of zones

By selecting «NUMBER OF ZONES» we select the number of zones that the panel has. There are 3 options as shown on the adjacent screen. The BS-1638 panel has 8 zones, the BS-1642 panel has 12 zones and the BS-1646 panel has 16 zones.

This option has to be changed only if a zone card is installed or removed. BS-1640 (4 zones) or the BS-1641 (4 zones).

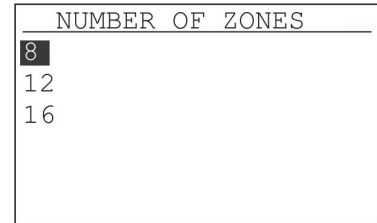

### 4.2.2 Sirens

This option has 2 submenus as shown in the adjacent screen.

We can adjust the delay of each siren from 0 to 6 minutes. This delay starts from when the panel issues an alarm until the siren is sounded. The delay is very useful in case of false alarms.

The second option determines the capability of automatically re-sounding the sirens when there is an alarm in a different zone. When it is active then the sirens will sound when there is an alarm in a different zone. In any other case they will not.

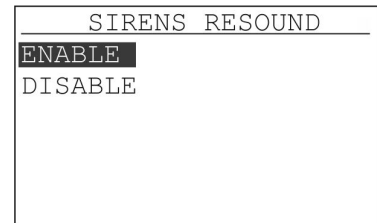
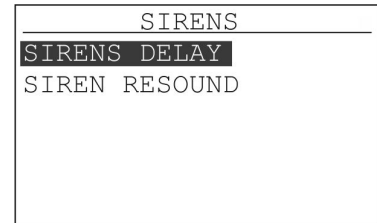

### 4.2.3 Aux Relay

The full function of the AUX relay is determined from the following options. The options «LOGIC AND» and «LOGIC OR» determine when the auxiliary relay will be activated.

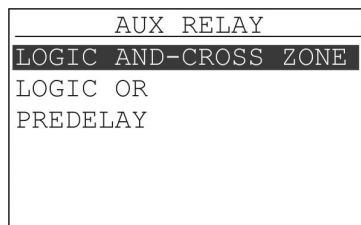

Figure 4-33. Auxiliary relay configuration

The option «LOGIC AND» (cross zone) determines which zones must be simultaneously activated in order for the relay to be activated. For example, in one installation we want zones 2 and 4 cross-zoned. Then we must have the following selected

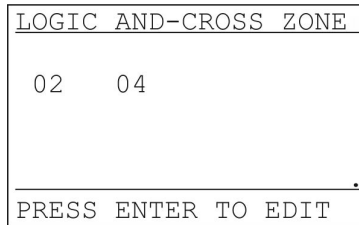
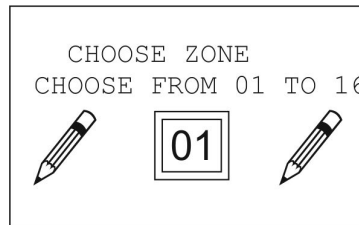
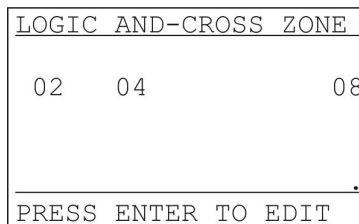

Figure 4-34. Logic AND (cross zone)

This means that the both zones, 2 and 4 must issue an alarm for the auxiliary relay to be activated. If we also want to cross-zones Zone 8 press «ENTER».



And with the keys «UP» and «DOWN» we select 08 and press «ENTER».



Now the cross-zones zones are 2,4 and 8. If we want to remove a zone we follow the same procedure.

With the key «ESC» we can exit from this option.

«LOGIC OR» (instant activation logic) determines which zones instantly activate the auxiliary relay during an alarm.

The setting procedure is identical to the «LOGIC AND» option.

Finally the delay of the auxiliary relay is set from 0 to 6 minutes.

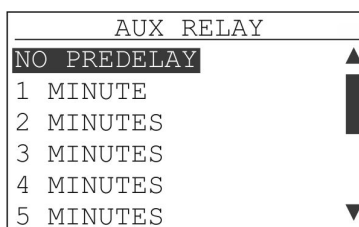



Figure 4-35. Delay for the auxiliary relay

  <p><i>for a safer world!</i></p>	Date	10/6/2022
	File	
	Document code	921163800_09_008
	Page	39 from 47

#### 4.2.4 Network configuration panel

This option configures each panel in the network of panels.

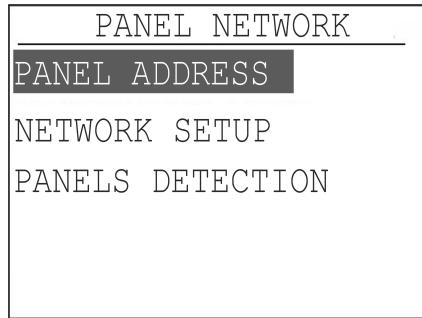

Figure 4-36. Menu network panels

In option PANEL ADDRESS define the address of the panel in the network from 1 to 16. If it is 1 it is the master panel. Otherwise it is a sub-panel.

In option NETWORK SETUP we declare if the network is enabled or disabled.

In the final option PANELS DETECTION detection is made by a central panel for all sub-panels connected to it.

### 4.3 Settings Menu

#### 4.3.1 Select Language

By selecting SELECT LANGUAGE and pressing ENTER we can see the adjacent screen. We can select the required language of the system.

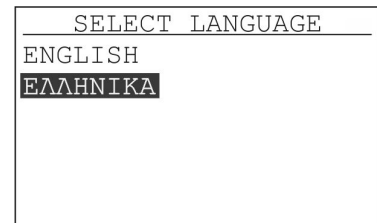

#### 4.3.2 Annual check warning

This option activates or deactivates the annual maintenance warning message.

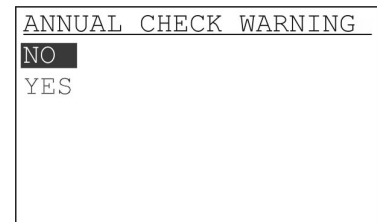

	Date	10/6/2022
	File	
	Document code	921163800_09_008
	Page	40 from 47

### 4.3.3 Reset defaults

To initialize all settings to the factory defaults select RESET DEFAULTS and press Enter. When you see the message in the adjacent screen the operation has finished. Next the panel will initialize and start for the main screen.



### 4.3.4 Annual check done

If we have a message for annual maintenance and we want to erase the message select the option ANNUAL CHECK DONE and press Enter. When you see the message in the adjacent screen the operation has finished.



### 4.3.5 Changing the technician code

By selecting CHANGE TECH CODE we see the adjacent screen. Use the up-down keys to increase or decrease the value of each digit and the right-left keys to change the digit. Once the new code has been entered press the ENTER key. The new code is also valid from programming with a P/C.

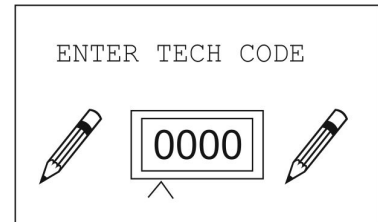

Finally there is the «MANUFACTURER MENU»

## 4.4 Clearing the events log

Selecting CLEAR EVENTS LOG and pressing Enter shows us the adjacent screen. The panel requests confirmation. If we really want to clear the log select YES and press Enter.

**Erase the events log immediately after finalizing the installation.**

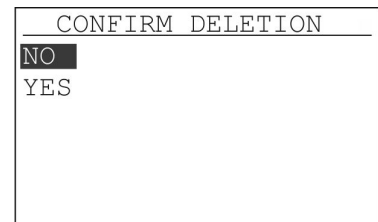



  <p>SAFETY &amp; SECURITY SYSTEMS</p> <p><i>for a safer world!</i></p>	Date	10/6/2022
	File	
	Document code	921163800_09_008
	Page	41 from 47

#### 4.5 Resetting the alarm counter

This option gives us the capability to reset the alarms counter. The alarms counter is a counter that counts all the alarm events and does not reset but only with this option. This option is issued in access level 4, that is why the DipSwitch 1 on the screen pcb must be in the ON position.

#### 4.6 Network settings

Selecting NETWORK and pressing Enter shows us the option for networking the panel. The panel can be connected to the network in order to cooperate with other panels of to be programmed with a P/C. We can see if the panel has an Ethernet card installed if we open the front lid. The Ethernet card will be connected to the pcb located on the lid of the panel. On this card we can see the characteristic RJ-45 connector.

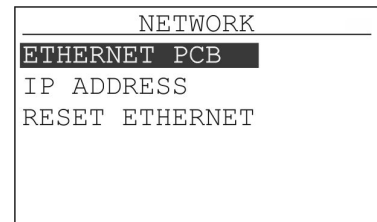

If there is an Ethernet card installed select the option ETHERNET PCB and press Enter. In the next screen select ACTIVE and press Enter.

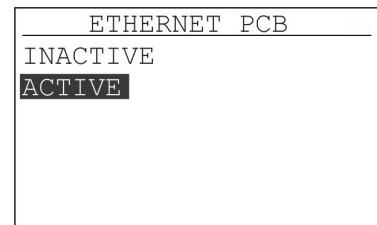

If we select IP ADDRESS and press Enter we see the adjacent screen. The panel must have an address that is part of the network that it belongs to. Ask your network manager to provide this address for you. The programming of the address is done using the arrow keys. With the up-down keys we can change the value of a digit and with the right-left keys we can change the digits. When the required IP address has been entered press Enter. By default the address is 10.0.1.149.

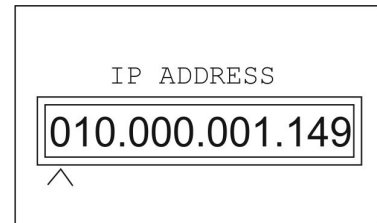

After any change in the network settings we must select the option RESET ETHERNET. This is to initialize the card with the new settings. The screen will show a message and it will return to the network menu.

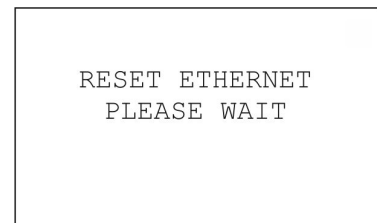

#### 4.7 Technician menu using the Ethernet

The programming of the panel can be done either by using the built-in keyboard and screen or alternatively by using a P/C. The default IP address is **10.0.1.149**. This can be changed to your preference and according to your network as it has been done in the screen shots below.

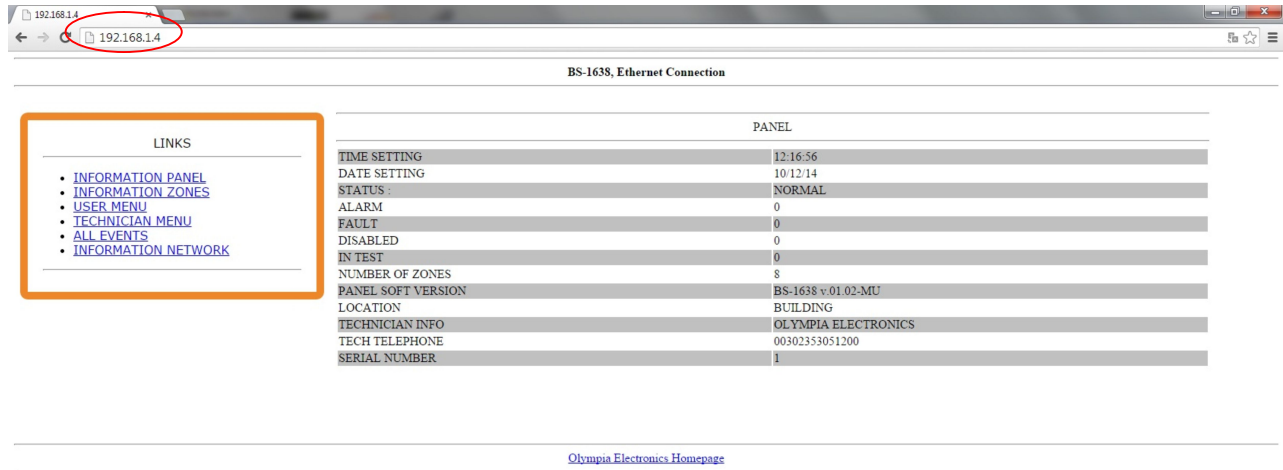

Select the link **TECHNICIAN MENU** and the following screen is shown.

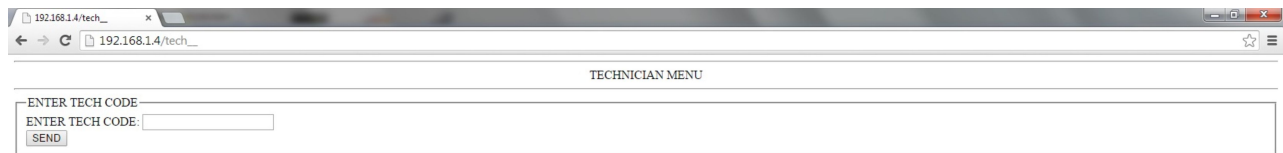

Place the cursor in the code entry field and type the correct technician code. After press **SEND**. If the code is correct then we can see the **TECHNICIAN MENU** as below.

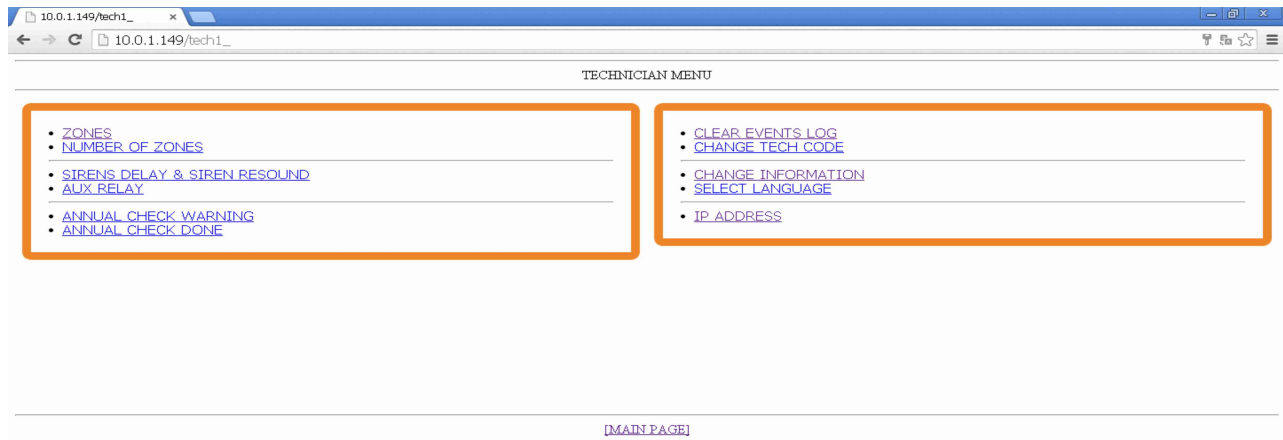

The structure of the menu is the same as in the technicians menu on the panel apart from some difference that can only be programmed from the P/C and are not available in the corresponding technician menu on the panel, such as changing the name of the zones.

Below are referenced in detail the options that are available only via the P/C.

 <b>olympia™ electronics</b> <small>SAFETY &amp; SECURITY SYSTEMS</small> <i>for a safer world!</i>	Date	10/6/2022
	File	
	Document code	921163800_09_008
	Page	43 from 47

### 4.7.1 Zone names

Using the mouse select ZONES and we can see the screen below. The operations that are selected are the factory defaults for all the zones.

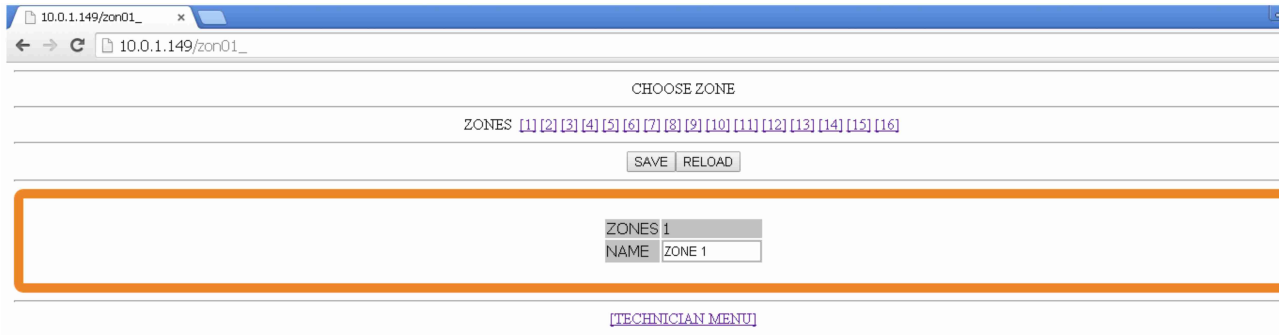

Via this selection we can program all options of the zones. First select the required zone and name it. Up to 12 uppercase characters are permitted, once finished press the SAVE button to store the changes. Repeat the process for the other zones.

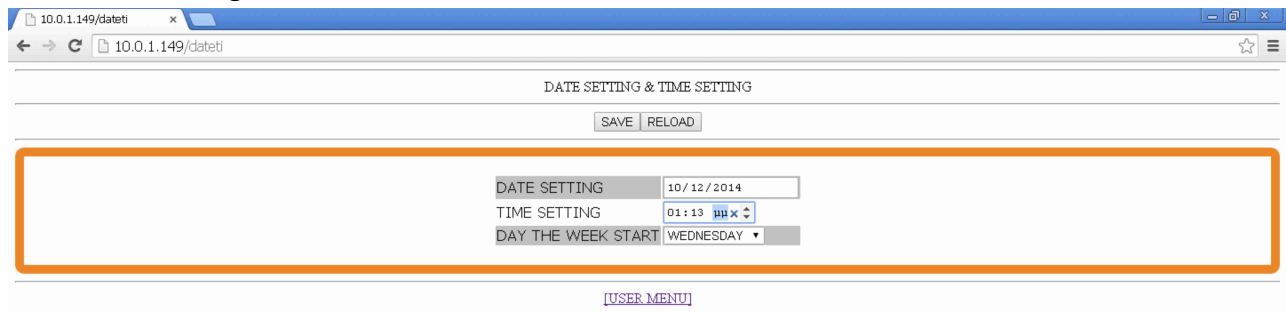

Select TECHNICIAN MENU to return to the initial screen of the technicians menu.

### 4.7.2 Setting the date and hour



Adjust the date, the time and the day of the week and press save. These settings must be adjusted in the beginning of the installation for the logged events to be correct.

By selecting TECHNICIAN MENU we return to the initial screen of the technician menu.

  <p>SAFETY &amp; SECURITY SYSTEMS</p> <p><i>for a safer world!</i></p>	Date	10/6/2022
	File	
	Document code	921163800_09_008
	Page	44 from 47

### 4.7.3 Other information

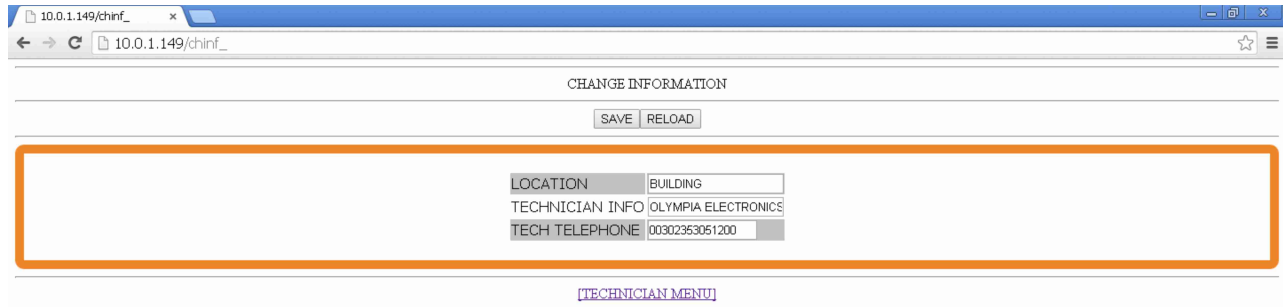

In this screen we can change the general information of the panel. The default information is shown in the screen above. We can change the LOCATION (up to 24 characters), the TECHNICIAN INFORMATION (up to 24 characters) and the TECHNICIAN TELEPHONE (up to 16 digits).

By pressing «SAVE» the changed settings are stored in the panel's memory.

By selecting TECHNICIAN MENU we return to the initial screen of the technician menu.

### 4.7.4 IP address

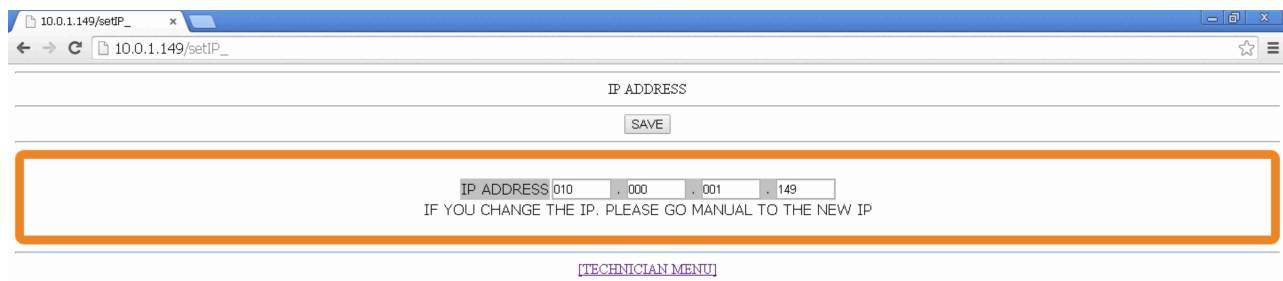

In this screen we can change the IP address of the panel. The default subnet mask is [255.255.255.0].

After changing the IP address press «SAVE» to store the changes to the panel memory. After saving, the communication with the panel will stop and we must manually enter the new IP address in the browser to establish a new connection.

The number entered must be with 3 digits. For example, if we want to enter the IP 192.168.1.2 we must enter it in the following manner 192.168.001.002.



for a safer world!

Date 10/6/2022

File

Document code 921163800\_09\_008

Page 45 from 47

## 5 Technical Characteristics - Specifications

Description	<b>BS-1638</b> Fire Detection panel with 8 zones	<b>BS-1642</b> Fire Detection panel with 12 zones	<b>BS-1646</b> Fire Detection panel with 16 zones
Mains power supply	220-240V AC/50-60HZ		
Consumption	100 VA		
Battery type	2 sealed lead acid batteries 12V / 7Ah		
Charger	Stabilized power supply 27,6V / 350mA		
Zone circuits	8 circuits that monitored for open and short-circuit conditions (maximum current 35mA)	12 circuits that monitored for open and short-circuit conditions (maximum current 35mA)	16 circuits that monitored for open and short-circuit conditions (maximum current 35mA)
Alarm circuits	Two 24V circuits that are monitored for open and short-circuit conditions (The maximum current for each circuit is 300mA). Each output is protected by a self resetting electronic fuse.		
Output 24P	24VDC ( ±3VDC) permanent output with a maximum current of 0.3A. The output is protected by a resetable electronic fuse.		
Output 24M	24VDC ( ±3VDC) output which is interrupted during a reset. The output has a maximum current output of 0.3 A  The output is protected by a self resetting electronic fuse.		
Output relays	Three relay contacts that can handle up to 30V DC and 5A maximum. Do not exceed these limits in any case.  All the output relays must be protected with fuses with the same rating.		
Total power	The total output power (zone circuits, siren circuits, outputs 24P and 24M) must not exceed 1A. I <sub>max a</sub> =I <sub>max b</sub> =1A, I <sub>min</sub> =60mA		
Battery cut of voltage	21V		
Maximum current batteries discharge	1A		
Battery maximum internal resistance R <sub>imax</sub>	10hm		



for a safer world!



Date 10/6/2022

File

Document code 921163800\_09\_008





Page 46 from 47

Autonomy	72 hours (Maximum number of connected detectors 220 and 16 zones, no loads connected to the 24V M and 24VP outputs) with two 12V/7Ah batteries.		
Degrees of cover protection	IP 30		
Cables	Cables suitable for fire detection systems such as FIP200, MICC, PYROFIL		
Fuse type	The panel has only one fuse that is replaceable and which protects the main power supply connection. This fuse has a rating of F 4A 250V TR5 and must be replaced with a fuse of the same type and rating.		
Operating temperature range	0 to 50 °C		
Humidity	Up to 95% relative humidity		
Construction material	ABS – polycarbonate, electrostatically painted steel		
Dimensions (LxWxH)	345 x 106 x 348 mm		
Weight(without batteries)	3740gr	3780gr	3820gr
Produced in accordance with	EN 54-2, EN 54-4		
Guarantee	2 years		
Optional panel functions	<p>The optional functions of the panel according to the norm EN 54-2 are</p> <ul style="list-style-type: none"> <li>• (Fire alarm device(s)) paragraph 7.8 ( EN 54-2 )</li> <li>• (Test condition) paragraph 10 ( EN 54-2 )</li> <li>• (Alarm counter) paragraph 7.13 ( EN 54-2 )</li> <li>• (Delays to outputs) paragraph 7.11 ( EN 54-2 )</li> </ul>		
Design	Components of the panels have been selected for the intended purpose, and are expected to operate within their specification when the environmental conditions outside the cabinet of the panel comply with class 3k5 of EN 60721-3-3:1995.		

  <p>SAFETY &amp; SECURITY SYSTEMS</p> <p><i>for a safer world!</i></p>	Date	10/6/2022
	File	
	Document code	921163800_09_008
	Page	47 from 47

## 5.1 Certification

The panels BS-1638, BS-1642 and BS-1646 are certified from EVPU. Also EVPU controls the production under CPR number: 1293-CPR-0512 for the panel BS-1638, BS-1642 and BS-1646. Below are the markings:

 <p><b>BS-1638</b></p> <p>CONVENTIONAL 8-ZONE FIRE ALARM PANEL INSTALL IN ACCORDANCE WITH PRODUCT MANUAL: 921163800_08_012 (GREEK) 921163800_09_007 (ENGLISH)</p> <p>POWER SUPPLY:  1293 220-240V AC/50-60Hz</p> <p>EN 54-2:1997 +A1:2006 EN 54-4:1997 +A1:2002 +A2:2006 1293-CPR-0512 DoP No:921163800_59_003 Provided option: Alarm counter, Delays to outputs, Test condition Output to fire alarm device(s) DISCONNECT POWER BEFORE SERVICING Production Date: <input type="text"/> / <input type="text"/> / <input type="text"/></p> <p>KOLINDROS PIERIAS 60061 GREECE</p>	 <p><b>BS-1642</b></p> <p>CONVENTIONAL 12-ZONE FIRE ALARM PANEL INSTALL IN ACCORDANCE WITH PRODUCT MANUAL: 921163800_08_012 (GREEK) 921163800_09_007 (ENGLISH)</p> <p>POWER SUPPLY:  1293 220-240V AC/50-60Hz</p> <p>EN 54-2:1997 +A1:2006 EN 54-4:1997 +A1:2002 +A2:2006 1293-CPR-0512 DoP No:921164200_59_003 Provided option: Alarm counter, Delays to outputs, Test condition Output to fire alarm device(s) DISCONNECT POWER BEFORE SERVICING Production Date: <input type="text"/> / <input type="text"/> / <input type="text"/></p> <p>KOLINDROS PIERIAS 60061 GREECE</p>	 <p><b>BS-1646</b></p> <p>CONVENTIONAL 16-ZONE FIRE ALARM PANEL INSTALL IN ACCORDANCE WITH PRODUCT MANUAL: 921163800_08_012 (GREEK) 921163800_09_007 (ENGLISH)</p> <p>POWER SUPPLY:  1293 220-240V AC/50-60Hz</p> <p>EN 54-2:1997 +A1:2006 EN 54-4:1997 +A1:2002 +A2:2006 1293-CPR-0512 DoP No:921164600_59_003 Provided option: Alarm counter, Delays to outputs, Test condition Output to fire alarm device(s) DISCONNECT POWER BEFORE SERVICING Production Date: <input type="text"/> / <input type="text"/> / <input type="text"/></p> <p>KOLINDROS PIERIAS 60061 GREECE</p>
---	--	--

## WARRANTY

Olympia Electronics guarantees the quality, condition and operation of the goods. The period of warranty is specified in the official catalogue of Olympia Electronics and also in the technical leaflet, which accompanies each product. This warranty ceases to exist if the buyer does not follow the technical instructions included in official documents given by Olympia Electronics or if the buyer modifies the goods provided or has any repairs or re-setting done by a third party, unless Olympia Electronics has fully agreed to them in writing. Products that have been damaged can be returned to the premises of our company for repair or replacement, as long as the warranty period is valid.

Olympia Electronics reserves the right to repair or to replace the returned goods and to or not charge the buyer depending on the reason of deflection. Olympia Electronics reserves the right to charge or not the buyer the transportation cost.

## HEAD OFFICE

72nd km. O.N.R. Thessaloniki-Katerini

P.C. 60061 Greece

[www.olympia-electronics.com](http://www.olympia-electronics.com)

[info@olympia-electronics.gr](mailto:info@olympia-electronics.gr)