

1

2

Battery Replacement

It can be done only by a competent person and after the mains interruption.

1. Follow step 1 of the installation instructions and remove the diffuser.
2. Follow step 2 of the installation instructions and remove the reflector.
3. Remove the old battery and place a new one of the same type and characteristics.
4. Replace the removed parts (previous steps 1 and 2).

NOTE: LED= Light Emitting Diode

LABELING EXPLANATION:

X: Self contained

1: Maintained operation (*)

A: Including test device

F: Automatic test gear complying with IEC 61347-2-7 denoted EL-T

60: 1 hour duration

180: 3 hours duration

480: 8 hours duration

X 1 A F 6 0

(*) **Maintained operation:** The luminaire lights its illumination source, when it is powered by the mains power supply or not.

Non Maintained operation: The luminaire lights its illumination source, only in mains power supply's failure.

ATTENTION!!!

 The light source contained in this luminaire shall only be replaced by the manufacturer, or his agent, or a similar qualified person.

NOTE!! The light source is non-user replaceable.



CAUTION : Do not view directly with bare eyes.

Technical Characteristics

OLY-1024			
OPERATION VOLTAGE	220-240V AC / 50-60Hz		
MAXIMUM POWER CONSUMPTION	4.6W / 4.8VA		
SUPPLY CURRENT	19mA		
U-OUT	22V		
Prated	1h: 2W	3h: 1.6W	8h: 0.5W
Irated	1h: 176mA	3h: 146mA	8h: 45mA
MAX OPEN CIRCUIT VOLTAGE	22V		
WIRE CROSS SECTION	0.5mm ² - 2.5mm ²		
MINIMUM POWER FACTOR	0.9		
BATTERY (Ni-Cd)	3.6V/3 Ah		
INSULATION BETWEEN SUPPLY & CONTROL TERMINALS	Basic insulation		
BATTERY PROTECTION	Deep discharge and overcharge protection / the control gear will recharge the battery normally after the test of 22.3		
MIN MAX. DISCHARGE VOLTAGE	3-4.5V		
MIN MAX. DISCHARGE CURRENT	1h: 500-900mA	3h: 410-695mA	8h: 130-215mA
MIN MAX. CHARGE CURRENT	190-210mA		
TRICKLE CHARGE VOLTAGE/CURRENT	100mA		
MAX CHARGE VOLTAGE	6V		
INDICATIONS	LED Charge, Lamp Fault LED, Battery Fault LED		
CHARGE TIME	24 hours		
MINIMUM DURATION	1 h, 3 h, 8 h		
LIGHT SOURCE	4 Power LEDs		
LIGHT SOURCE LUMINOUS FLUX (MAINS / EMERGENCY)	300lm / 380lm (1 h), 320lm (3 h), 100lm (8 h)		
DEGREES OF COVER PROTECTION	IP42		
PRODUCED IN ACCORDANCE WITH	EN 60598-1, EN 60598-2-22, EN 55015, EN 61547, EN 61000-3-2, EN 61000-3-3		
CONTROL GEAR MAX. TEMPERATURE:tc	50 °C at R18/R19		
OPERATION TEMPERATURE RANGE	5 to 40 °C		
RELATIVE HUMIDITY	Up to 95%		
CONSTRUCTION MATERIAL	ABS/PC, PC		
EXTERNAL DIMENSION (L x W x H)	270 x 147 x 48 mm		
WEIGHT	750gr.		
GUARANTEE	3 years (1 year for the battery)		
CONTROL GEAR WITH AUTOMATIC TEST FUNCTION	EL-T		

LED Characteristics

OLY-1024			
MANUFACTURER	Olympia Electronics S.A.		
MODEL NUMBER	2801205		
VOLTAGE RANGE	10-12V DC		
NOMINAL POWER	1h: 2W	3h: 1.6W	8h: 0.5W
CONNECTIONS	Non reversible connection between main pcb and led module		
TEMPERATURE (tc)	50 °C max. across the board		

Warranty

Olympia Electronics guarantees the quality, condition and operation of the goods. The period of warranty is specified in the official catalogue of Olympia Electronics and also in the technical leaflet, which accompanies each product. This warranty ceases to exist if the buyer does not follow the technical instructions included in official documents given by Olympia Electronics or if the buyer modifies the goods provided or has any repairs or re-setting done by a third party, unless Olympia Electronics has fully agreed to them in writing. Products that have been damaged can be returned to the premises of our company for repair or replacement, as long as the warranty period is valid.

Olympia Electronics reserves the right to repair or to replace the returned goods and to or not charge the buyer depending on the reason of defection. Olympia Electronics reserves the right to charge or not the buyer the transportation cost.



72nd km. O.N.R. Thessaloniki-Katerini
P.C. 60300 P.O. Box 06 Eginio Pierias Greece

www.olympia-electronics.gr
info@olympia-electronics.gr



OLY-1024

SELF TESTING MAINTAINED/NON MAINTAINED EMERGENCY LUMINAIRE



Thank you for your trust in our products
Olympia Electronics - European manufacturer

Package Contents

- 1 Luminaire
- 1 Mounting accessories
- 1 Manual

General

These devices are used indoors (ta 40°C) in places where emergency light is needed. Each device must be permanently connected to mains power supply. In normal operation the battery is charging. The light source can be either on or off, depending on user's choice. In case of a mains power supply failure, the device enters emergency mode and the illumination LED turns on. When the mains power supply is restored the device turns to normal operation.

Autonomy Duration Selection

The user can select one of the 3 available minimum autonomy durations 1 hour, 3 hours and 8 hours. The selection must be done while the luminaire is disconnected from AC and battery supplies. The selection is achieved through Switches 2 & 3 of DS1 as shown below.

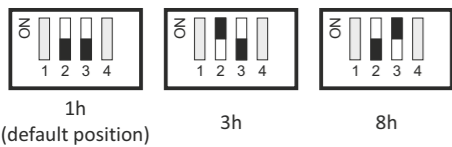

Technical Label Installation

Two additional labels are included in the package, one for 3 hours duration (180) and one for 8 hour duration (480). Depending on the selected duration, the installer must cover the default 1 hour (60) printing with one label that has the required duration. Please take notice of the orientation of the label.

Manual Operational Test

Remove the diffuser and then by pressing the test button briefly an operation test is initiated. The light source and the emergency circuit of the device are tested. The manual test can be conducted only if the mains power supply and the battery are connected. During this test period the LAMP TEST LED will blink. The battery must have adequate charge. This test lasts for 3 seconds.

Manual Autonomy Test

A duration test can be conducted by pushing the button steadily for 5 to 10 seconds. In order to be performed, the mains power supply should be connected and the battery should be fully charged. The luminaire enters emergency mode, the CHARGE LED is turned OFF and the BATTERY FAULT LED starts blinking. Its duration is the stated autonomy duration of the luminaire. If at the end of the test the autonomy

is lower than the nominal, the BATTERY FAULT LED will lit and battery needs to be replaced. If the result of the test is good then the luminaire enters charging mode and the CHARGE LED starts blinking until the battery is fully charged.

Automatic Operational Test

This test includes all the operations that are provided in Manual Operational Test and is conducted automatically every 15 days and lasts 3 seconds.

Automatic Autonomy Test

The Automatic Autonomy Test is conducted every 6 months and measures the device's back up operation and emergency duration. This test includes all functions of the Manual Autonomy Test.

ATTENTION!!!

1. Operations for installation, maintenance or testing must be done by authorized personnel only.
2. Always use in any case round mains cable, with a diameter of 5-10mm (H05RN-F type 2x1mm² or any other type, at least equal to it's mechanical and electrical properties). ATTENTION!! The cable must not be deformed in any way (This requirement is important to ensure the IP rating).
3. The device must be connected to the mains power supply through a circuit breaker that is depends on the total line's power load.
4. In case of battery replacement, it must be replaced by the same type, by the manufacturer or a competent person.
5. In case of inactive use for a period greater than 2 months, disconnect the battery by pulling out the battery's connector.
6. It is not allowed to discard batteries into common trash bins, they must be discarded only in battery recycling points. Do not incinerate.

Indications LED Status

CHARGE (green)	LAMP FAULT (red)	BATT. FAULT (yellow)	Description
●	●	●	Charging
●	∅	∅	Fully charged
∅	∅	∅	Battery fault or emergency mode
∅	●	∅	Operational test
∅	●	∅	Light source fault
∅	∅	●	Autonomy test
∅	∅	●	Duration fault

Note:

●	Permanently ON
●	Blink
∅	Off
∅	Indifferent

Installation Instructions

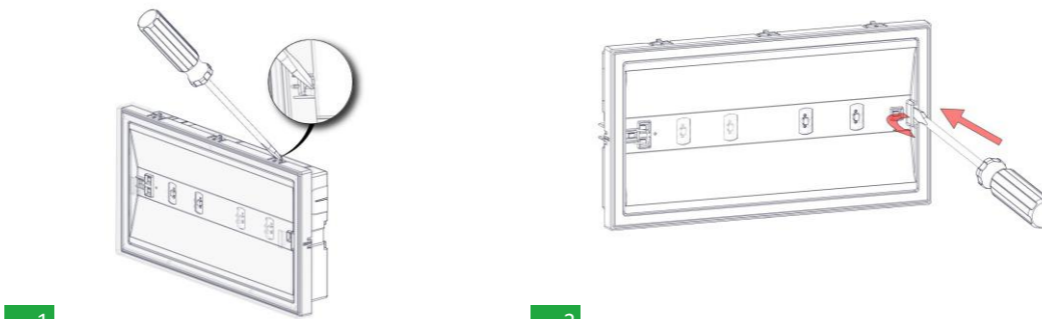

1

2



3

4

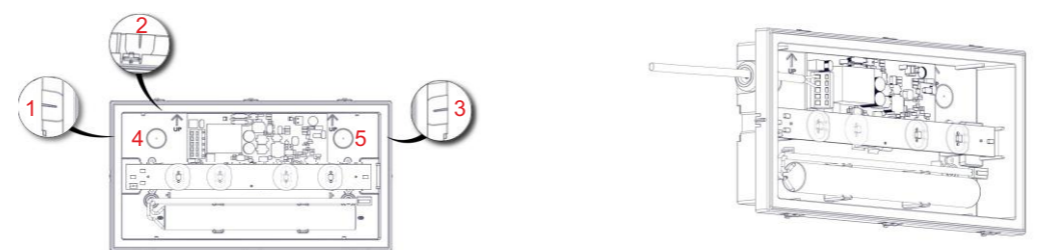

5

Drill one of the available 5 holes with a 16-18mm drill bit. Install the included rubber gasket and pass through the power cables. Install the included tie (if needed) to fasten and securely the power cables.

6) Autonomy Duration Selection (Read on General Informations, Page 1)

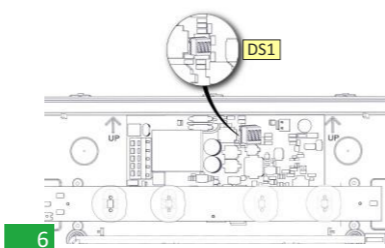

6

7 a) Permanent Maintained Operation

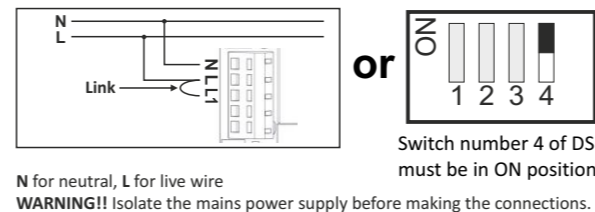

N for neutral, L for live wire
WARNING!! Isolate the mains power supply before making the connections.

7

7 b) Non-Maintained Operation

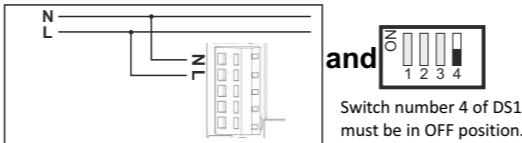

and
Switch number 4 of DS1 must be in OFF position.

N for neutral, L for live wire **WARNING!!** Isolate the mains power supply before making the connections.

7

7 c) Controlled Maintained Operation of the lamp

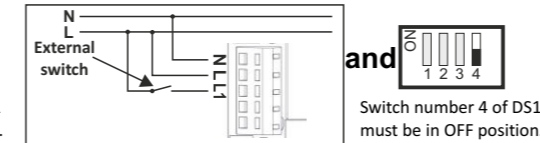

and
Switch number 4 of DS1 must be in OFF position.

Battery Connection



8

9

10

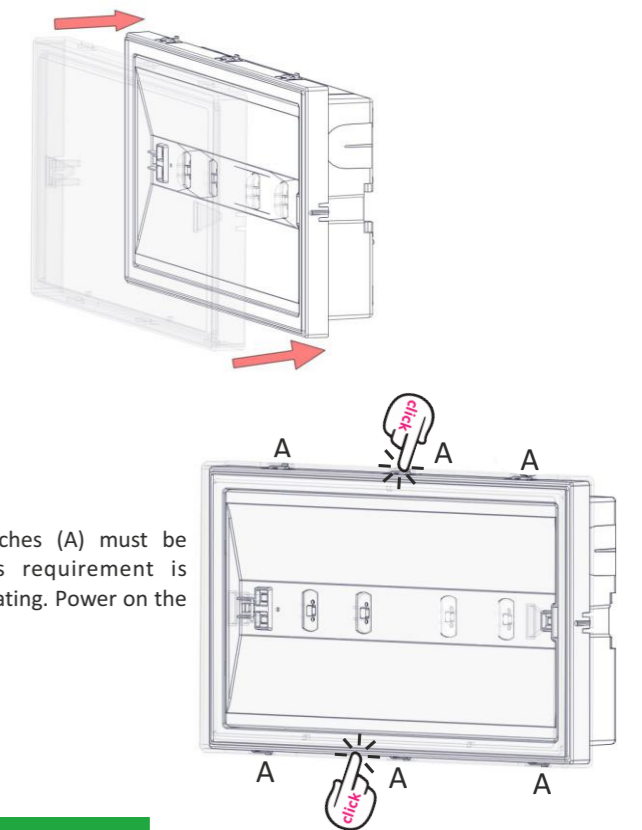

Attention!! The 6 plastic latches (A) must be secured (click sound). This requirement is important to ensure the IP42 rating. Power on the luminaire.

11

Mounting Methods

Oly luminaires can be surface mounted on walls or ceilings. For these mounted installations, special accessories are included.

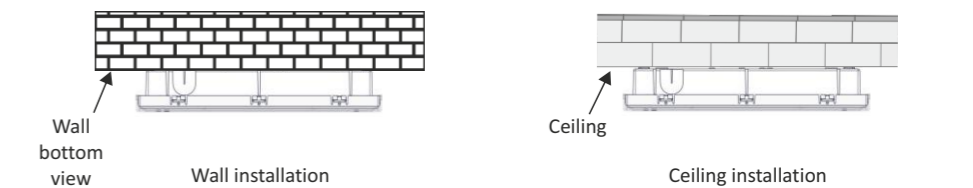

Suspended installation with A-3018 accessory

The luminaire can be installed in a suspended ceiling.



Extra Mounting Methods *

* **ATTENTION!!!** The below mounting methods can be done after request of the necessary mounting accessories!!

A marking panel (SP-1100) can be installed on the luminaire pointing the desired direction.

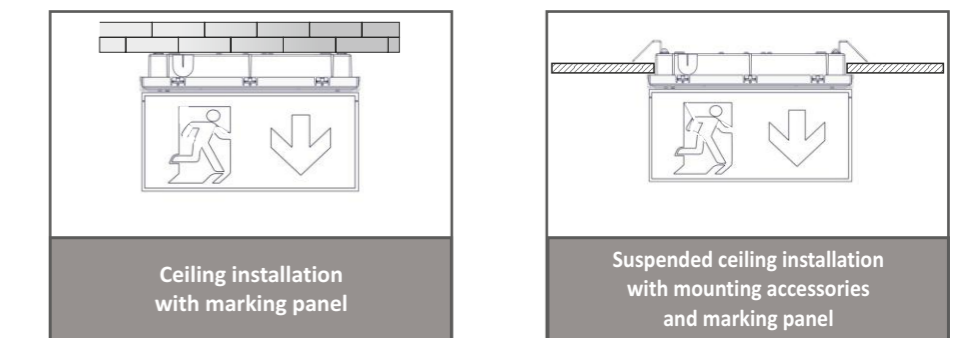

NOTE!!

After finishing the installation you must power the luminaire for at least 24 hours in order to completely charge the battery. The rated autonomy duration can be achieved after that time.