

## Package Contents

- 1 Luminaire
- 3 Pictograms (R/L/D)
- 1 Mounting accessories
- 1 Manual

## General

These devices are used in places where emergency light is needed. Each device must be permanently connected to mains power supply. In normal operation the battery is charging. In case of a mains power supply failure, the device enters emergency mode and the illumination LED turns on. When the mains power supply is restored the device turns to normal operation.

### Manual Operational Test

An operational test is initiated by placing the test card beside the indicators and removing it instantly. The light source and the emergency circuit of the device are tested. The manual test can be conducted only if the mains power supply and the battery are connected. During this test period, the light source turns on, and all indication LEDs are OFF. The battery must have adequate charge. This test lasts for 3 seconds.

### Automatic Operational Test

This test includes all the operations that are provided in Manual Operational Test and is conducted automatically every 15 days and lasts 3 seconds.

### Automatic Autonomy Test

The Automatic Autonomy Test is conducted every 6 months and measures the device's backup operation and emergency duration. In order to be performed, the mains power supply and the battery should be connected and fully charged. If the battery is not fully charged, the test is postponed until the battery is completely charged. If during this test, the autonomy is less than nominal, then the battery fault LED turns on continuously, and the battery must be replaced.

### Resetting Errors

Place the test card A-1900 beside the indicators (page 4) and remove it after the reset is conducted (the indicators light in sequence) to clear all indicated LED errors. Then, the luminaire enters regular operation mode.

### ATTENTION!!!

1. Operations for installation, maintenance or testing must be done by authorized personnel only.
2. Always use in any case round mains cable, with a diameter of 5-10mm (H05RN-F type 2x1mm<sup>2</sup> or any other type, at least equal to its mechanical and electrical properties). ATTENTION!! The cable must not be deformed in any way (This requirement is important to ensure the IP rating).
3. The device must be connected to the mains power supply through a circuit breaker that depends on the total line's power load.
4. In case of battery replacement, it must be replaced by the same type, by the manufacturer or a competent person.
5. In case of inactive use for a period greater than 2 months, disconnect the battery by pulling out the battery's connector.
6. It is not allowed to discard batteries into common trash bins, they must be discarded only in battery recycling points. Do not incinerate.

## Indications LED Status

GREEN (charge)	RED (Lamp Fault)	RED (Bat. Fault)	Description
●	○	○	Good charge condition
○	○	○	Mains off (battery not connected or charger fault)
●	○	●	Autonomy or low battery problem
○	○	●	No charging current or disconnected battery
∅	●	∅	Light Source Fault (with light source off)
∅	●	∅	Problem in the light source (with light source on)
<b>Note:</b>			● Permanently ON   ● Blink   ○ Off   ∅ Non relevant

## Installation

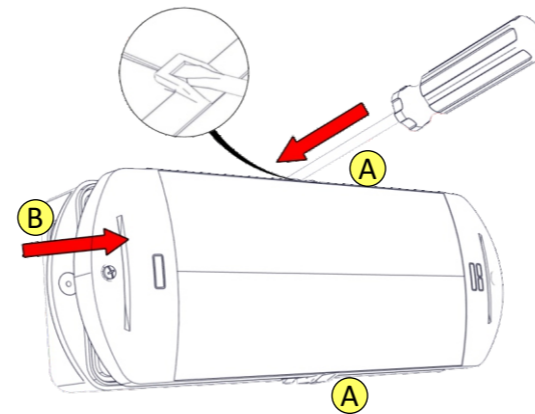

To dismantle the luminaire, simply remove the diffuser.  
**ATTENTION!** If the 2 plastic latches (A) are clipped, carefully insert a flat-blade screwdriver to unclip them. Then, gently lift the diffuser (B) upwards to detach it.

1

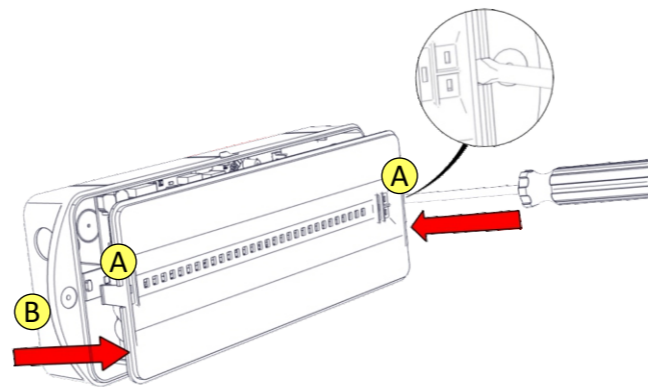

Place a flat blade screwdriver to the recesses (A) and pull up gently the reflector (B) to remove it.

2

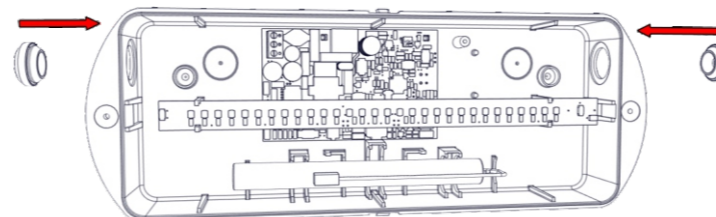

Install the two rubber gaskets to the holes of the base. Make sure that they are not deformed.

3

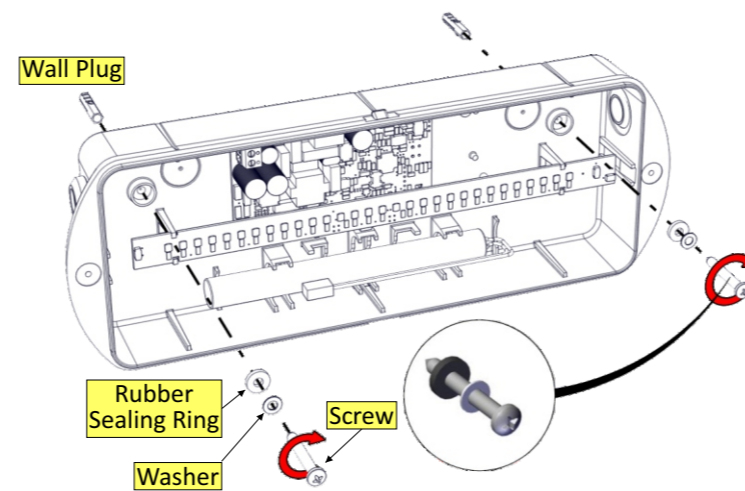

Install the plastic base (with the included mounting accessories).  
**WARNING!!** To preserve the IP65 rating, fit the screws with the metallic washers and rubber sealing rings.

4

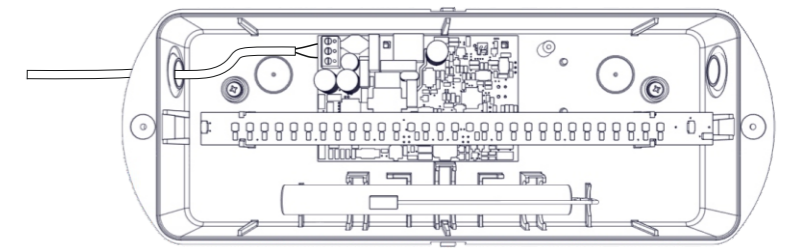

### Controlled operation of the lamp

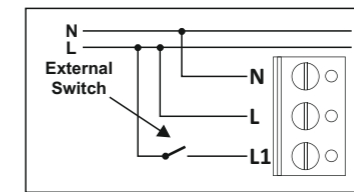

### Permanent maintained operation

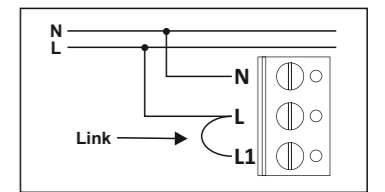

Make a hole in the center of the rubber gasket by using a small screwdriver. Pass the round cable through the rubber gasket. Connect the mains cable according to the connections diagrams above. **N** for neutral, **L** for live wire **WARNING!!** Isolate the mains power supply before making the connections.

5

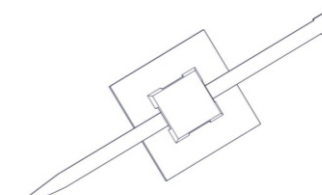

Install the included tie-wrap to the adhesive tether loop and fasten securely the power cable in order to anchor it.

6

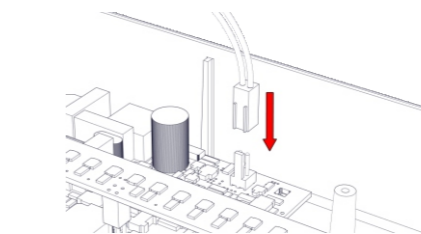

Place the battery's connector to the corresponding connector on the PCB.

7

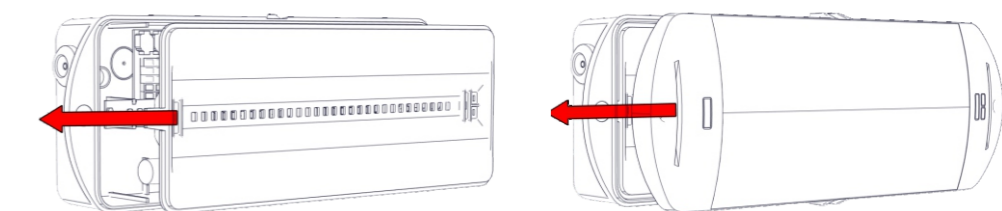

Refit the reflector and then the diffuser, which were removed in steps 1 & 2. Mind the holes of the indications.

8

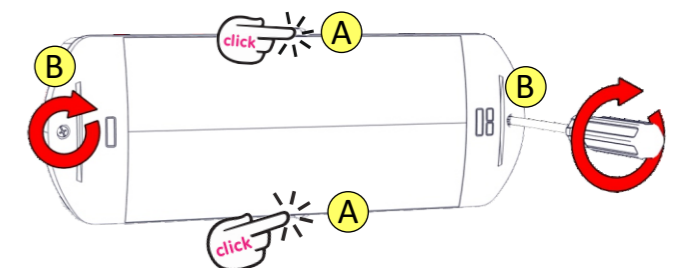

The plastic latches (A) must be secured (click sound).  
Fasten the 2 screws (B). (Tightening torque 1.2N\*m)

9

### NOTE!!

After finishing the installation you must power the luminaire for at least 24 hours in order to completely charge the battery. The rated autonomy duration can be achieved after that time.

## Battery Replacement

It can be done only by a competent person and after the mains interruption.

1. Follow step 1 of the installation instructions and remove the diffusor.
2. Follow step 2 of the installation instructions and remove the reflector.
3. Remove the old battery and place a new one of the same type and characteristics.
4. Replace the removed parts (previous steps 1 and 2).

## Dimensional drawing:

315 x 120 x 65 mm

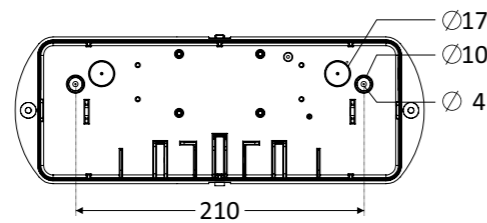
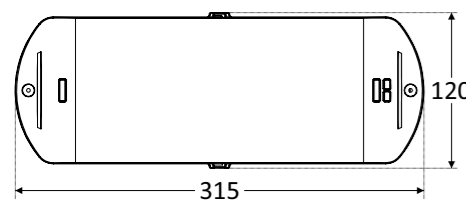
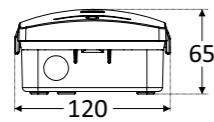
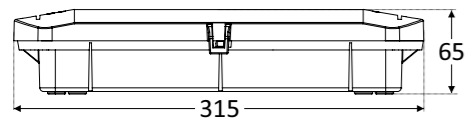

## A-1900 Magnetic Test Card

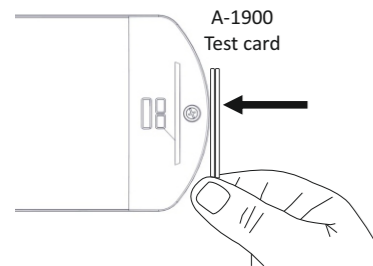

### A-1900 Test card (not included).

This card is available only upon request.

To use it, place the card beside the indicators.

For the Manual Operational Test, place the card and remove it immediately.

For resetting errors, place the card and remove it after the indicator LEDs light in sequence.

**NOTE: LED= Light Emitting Diode**

### LABELING EXPLANATION:

X: Self contained

1: Maintained/Non maintained operation (\*)

A: Including test device

G: Internally illuminated safety sign

90: 1.5 hour duration

180: 3 hours duration

(\*) **Maintained operation:** The luminaire lights its illumination source, when it is powered by the mains power supply or not.

**Non Maintained operation:** The luminaire lights its illumination source, only in power supply's failure.

NOTE!! The installer should fill in, on the specification label, the letter **G** if the luminaire is used as a safety sign.

X 1 A 90

### ATTENTION

The light source contained in this luminaire shall only be replaced by the manufacturer, or his agent, or a similar qualified person.

NOTE! The light source is non-user replaceable.

## Technical Characteristics

	GR-1938/4P	GR-1939/4P	GR-1938/6P	GR-1939/6P
OPERATION VOLTAGE	220-240V AC/50-60Hz			
MAXIMUM POWER CONSUMPTION	4.7W / 5.1VA	5.3W / 5.7VA	6.2W / 6.5VA	
WIRE CROSS SECTION	0.8 - 2.5 mm <sup>2</sup>			
BATTERY (Ni-Cd)	4.8V/1.5Ah	4.8V/3Ah	4.8V/4Ah (Ni-MH)	
BATTERY PROTECTION	Deep discharge and overcharge protection			
INDICATIONS/CONTROLS	The control gear will recharge the battery normally after the test of 22.3			
CHARGE TIME	24h			
MINIMUM DURATION	90min	180min	90min	180min
LIGHT SOURCE	4 white LEDs		6 white LEDs	
LIGHT SOURCE LUMINOUS FLUX (MAINS)	175lm		245lm	
LIGHT SOURCE LUMINOUS FLUX (EMERGENCY)	350lm		480lm	
DEGREES OF COVER PROTECTION	IP65			
PRODUCED IN ACCORDANCE WITH	EN 60598-1, EN 60598-2-22, EN 55015, EN 61547, EN 61000-3-2, EN 61000-3-3			
VIEWING DISTANCE (as safety sign)	22m			
OPERATION TEMPERATURE RANGE	5 to 40 °C			
RELATIVE HUMIDITY	Up to 95%			
CONSTRUCTION MATERIAL	ABS/PC, PC			
EXTERNAL DIMENSIONS (L x W x H)	315 x 120 x 65 mm			
WEIGHT	750gr.	800gr.	850gr.	
GUARANTEE	3 years (1 year for the battery)			

## LED Characteristics

MANUFACTURER	Olympia Electronics S.A.		
MODEL NUMBER	1509153/4P	1509153/6P	
VOLTAGE RANGE	11.6-13.6 V DC		
NOMINAL POWER	4 W	6 W	
CONNECTIONS	Non reversible connection between main pcb and led module		
TEMPERATURE (tc)	65 °C max. across the board		

## Warranty

Olympia Electronics guarantees the quality, condition and operation of the goods. The period of warranty is specified in the official catalogue of Olympia Electronics and also in the technical leaflet, which accompanies each product. This warranty ceases to exist if the buyer does not follow the technical instructions included in official documents given by Olympia Electronics or if the buyer modifies the goods provided or has any repairs or re-setting done by a third party, unless Olympia Electronics has fully agreed to them in writing. Products that have been damaged can be returned to the premises of our company for repair or replacement, as long as the warranty period is valid.

Olympia Electronics reserves the right to repair or to replace the returned goods and to or not charge the buyer depending on the reason of deflection. Olympia Electronics reserves the right to charge or not the buyer the transportation cost.



72nd km. O.N.R. Thessaloniki-Katerini  
P.C. 60300 P.O. Box 06 Eginio Pierias Greece

[www.olympia-electronics.com](http://www.olympia-electronics.com)

[info@olympia-electronics.gr](mailto:info@olympia-electronics.gr)



GR-1938/4P  
GR-1939/4P

GR-1938/6P  
GR-1939/6P

WATERPROOF SELF TESTING  
MAINTAINED/NON MAINTAINED  
EMERGENCY LUMINAIRE

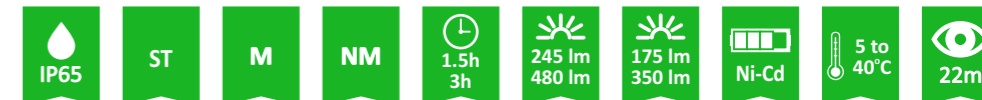

Thank you for your trust in our products  
Olympia Electronics - European manufacturer