

NOTE: LED= Light Emitting Diode

LABELING EXPLANATION:

X: Self contained

1: Maintained operation (*)

A: Including test device

E: With non-replacable lamp(s) and/or battery

F: Automatic test gear complying with IEC 61347-2-7 denoted EL-T

G: Internally illuminated safety sign

90: 1.5 hour duration

180: 3 hours duration

(*) **Maintained operation:** The luminaire lights its illumination source, when it is powered by the mains power supply or not.

Non Maintained operation: The luminaire lights its illumination source, only in mains power supply's failure.

NOTE!! The installer should fill in, on the specification label, the letter **G** if the luminaire is used as a safety sign.



ATTENTION!!!

The light source of this luminaire is not replaceable when the light source reaches its end of life the whole luminaire shall be replaced.



CAUTION : Do not view directly with bare eyes.

Technical Characteristics

	SLL-501/WP	SLL-503/WP
OPERATION VOLTAGE	220-240V AC / 50-60Hz	
MAXIMUM POWER CONSUMPTION	7.8W / 8.2VA	
SUPPLY CURRENT	38mA	
U-OUT	25V	
Prated	2.7W	
Irated	185mA	
MAX OPEN CIRCUIT VOLTAGE	25V	
WIRE CROSS SECTION	0.5mm ² - 2.5mm ²	
MINIMUM POWER FACTOR	0.89	
BATTERY (Ni-Cd)	4.8V/1.5Ah	4.8V/3Ah
INSULATION BETWEEN SUPPLY & CONTROL TERMINALS	Basic insulation	
INSULATION BETWEEN SUPPLY & BATTERY CIRCUIT	Basic insulation	
BATTERY PROTECTION	Deep discharge and overcharge protection / the control gear will recharge the battery normally after the test of 22.3	
MIN MAX. DISCHARGE VOLTAGE	4 - 6V	
MIN MAX. DISCHARGE CURRENT	500 - 730mA	
MIN MAX. CHARGE CURRENT	240 - 260mA	
TRICKLE CHARGE VOLTAGE/CURRENT	5.7V / 30mA	
MAX CHARGE VOLTAGE	6V	
INDICATIONS	LED Charge, Lamp Fault LED, Battery Fault LED	
CHARGE TIME	24 hours	
MINIMUM DURATION	1.5 hour	3 hours
LIGHT SOURCE	30 white LEDs	
LIGHT SOURCE LUMINOUS FLUX (MAINS / EMERGENCY)	500lm / 500lm	
DEGREES OF COVER PROTECTION	IP65	
PRODUCED IN ACCORDANCE WITH	EN 60598-1, EN 60598-2-22, EN 55015, EN 61547, EN 61000-3-2, EN 61000-3-3	
VIEWING DISTANCE (as safety sign)	30m	
OPERATION TEMPERATURE RANGE	5 to 40 °C	
CONTROL GEAR MAX.TEMPERATURE: tc	74 °C at Z3	
RELATIVE HUMIDITY	Up to 95%	
CONSTRUCTION MATERIAL	ABS/PC, PC	
EXTERNAL DIMENSION (L x W x H)	322 x 162 x 58 mm	
WEIGHT	969gr.	1061gr.
GUARANTEE	3 years (1 year for the battery)	
CONTROL GEAR WITH AUTOMATIC TEST FUNCTION	EL-T	

LED Characteristics

	SLL-501/WP	SLL-503/WP
MANUFACTURER	Olympia Electronics S.A.	
MODEL NUMBER	1603195	
VOLTAGE RANGE	13.3-14.3V DC	
NOMINAL POWER	2.7W	
CONNECTIONS	Fixed connection between main pcb and led module	
TEMPERATURE (tc)	60 °C max. across the board	

Warranty

Olympia Electronics guarantees the quality, condition and operation of the goods. The period of warranty is specified in the official catalogue of Olympia Electronics and also in the technical leaflet, which accompanies each product. This warranty ceases to exist if the buyer does not follow the technical instructions included in official documents given by Olympia Electronics or if the buyer modifies the goods provided or has any repairs or re-setting done by a third party, unless Olympia Electronics has fully agreed to them in writing. Products that have been damaged can be returned to the premises of our company for repair or replacement, as long as the warranty period is valid.

Olympia Electronics reserves the right to repair or to replace the returned goods and to or not charge the buyer depending on the reason of deflection. Olympia Electronics reserves the right to charge or not the buyer the transportation cost.



72nd km. O.N.R. Thessaloniki-Katerini
P.C. 60300 P.O. Box 06 Eginio Pierias Greece
www.olympia-electronics.gr
info@olympia-electronics.gr

923503000_09_002



SLL-501/WP & SLL-503/WP

**WATERPROOF SELFTESTING
MAINTAINED/NON MAINTAINED
EMERGENCY LUMINAIRES**



Thank you for your trust in our products
Olympia Electronics - European manufacturer

Package Contents

1	Luminaire
1	Set of Pictograms
1	Mounting accessories
1	Manual

General

These devices are used indoors (ta 40°C) in places where emergency light is needed. Each device must be permanently connected to mains power supply. In normal operation the battery is charging. In case of a mains power supply failure, the device enters emergency mode and the illumination LED turns on. When the mains power supply is restored the device turns to normal operation.

Battery Charging

The battery charging is completely controlled by microprocessor and is protected from complete discharge and overcharge.

Battery Cut-off

The luminaire enters in this mode when the mains power supply fails and battery has lost its energy. During this mode the luminaire enters the idle state and battery consumption is negligible, in order to be protected from deep discharge.

Automatic Operational Test

This test is conducted automatically every 15 days and lasts 3 seconds. In order to be performed, the mains power supply and the battery should be connected. The light source and the emergency circuit of the device are tested.

Automatic Autonomy Test

The Automatic Autonomy Test tests the device's back up operation and emergency duration. This test is conducted automatically every 6 months and its duration is the stated autonomy duration of the luminaire. In order to be performed, the mains power supply should be connected and the battery must be fully charged. If the battery is not fully charged, the test is postponed until the battery is completely charged. If during this test, the autonomy is less than nominal then the battery fault LED will permanently be on and the battery must be replaced.

Indications LED Status

CHARGE (green)	LAMP FAULT (red)	BATT. FAULT (yellow)	Description
			Charging
			Fully charged
			Battery fault or emergency mode
			Operational test
			Light source fault
			Autonomy test
			Duration fault

Note:

	Permanently ON
	Blink
	Off
	Indifferent

Back Up Operation

The autonomy duration of battery during emergency mode must be at least as the one stated in the list of the technical characteristics. During emergency mode, a light source test is also performed.

ATTENTION!!!

- Operations for installation, maintenance or testing must be done by authorized personnel only.
- The device must be connected to the mains power supply through a fuse that is dependent on the total line's power load.
- In case of battery replacement, it must be replaced by the same type, by the manufacturer or a competent person.
- In case of inactive use for a period greater than 2 months, disconnect the battery by pulling out the battery's connector.
- If the luminaire no longer meets the rated duration of operation, after the corresponding recharge period, the battery must be replaced.
- Always use in any case round mains cable, with a diameter of 5-10mm (H05RN-F type 2x1mm² or any other type, at least equal to its mechanical and electrical properties). ATTENTION!! The cable must not be deformed in any way (This requirement is important to ensure the IP rating).
- The control gear within this luminaire is a built in control gear which relies on the luminaire for protection against electric shock.
- The control gear is proof against supply voltage polarity reversal.
- This control gear has mains connected primary windings.
- It is not allowed to discard batteries into common trash bins, they must be discarded only in battery recycling points. Do not incinerate.**

Connectors

- KL1: Power connector
 KL2: Non user terminal
 CN4: Battery connector
 CN5: LED connector
 CN6: Non user connector
 CN7: Non user terminal

Installation Instructions

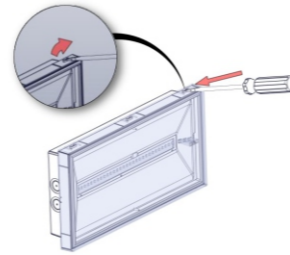

1

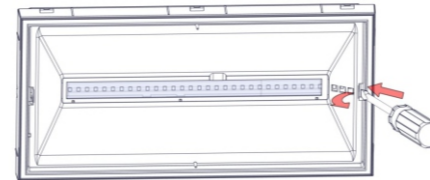

2

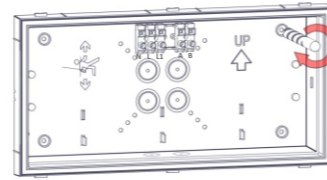

3

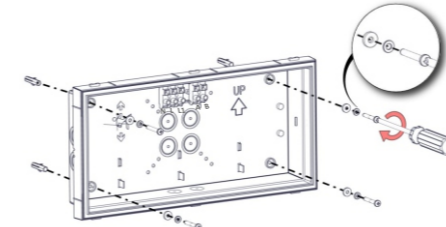

4

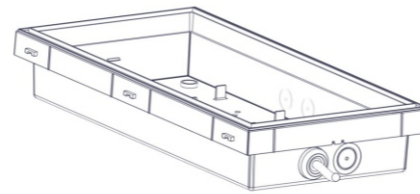

5

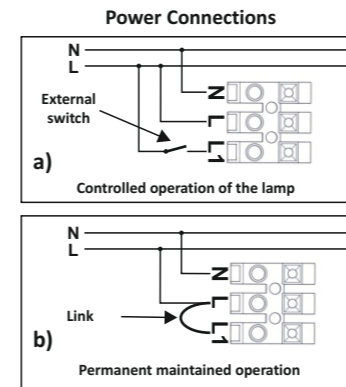

Always use in any case round mains cable, with a diameter of 5-10mm (H05RN-F type 2x1mm² or any other type, at least equal to its mechanical and electrical properties). ATTENTION!! The cable must not be deformed in any way (This requirement is important to ensure the IP rating).

N for neutral, L for live wire and L1 for the maintained operation.

6

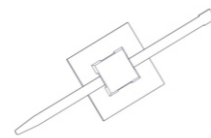

Install the included tie (if needed) to fasten securely the power cables.

7

Battery Connection

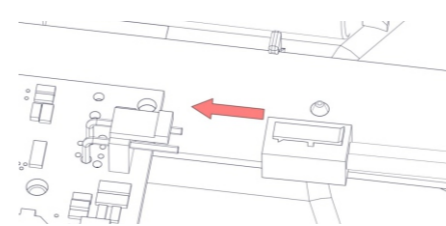

8

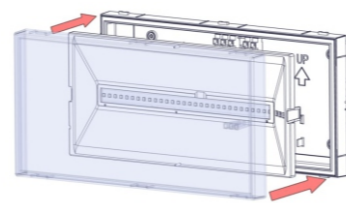

9

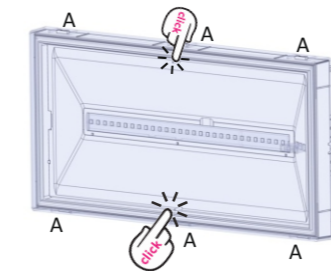

Attention!! The plastic latches (A) must be secured (click sound). This requirement is important to ensure the IP65 rating. Power on the luminaire.

10

This unit has replaceable batteries that can be replaced or changed by the manufacturer or a competent person.

Commissioning

- After installation, a 24 hours charging cycle must be completed, in order to achieve the nominal autonomy.
- During commissioning of the luminaire write the commissioning date on the battery.
- When power is applied to the unit inspect that the CHARGE indicator is either blinking or steady, all other indicators are OFF and that the led lamp is lit (maintained operation) or OFF (non-maintained operation)
- A full duration test should be conducted after verifying that the CHARGE indicator is continuously ON. Test is initiated by isolating the mains power supply. Verify that the LED lamp is lit during the test period for at least the stated duration.

Pictogram Installation

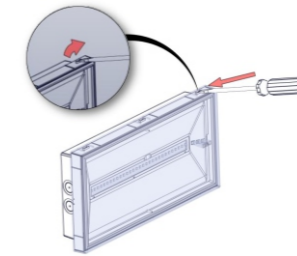

1

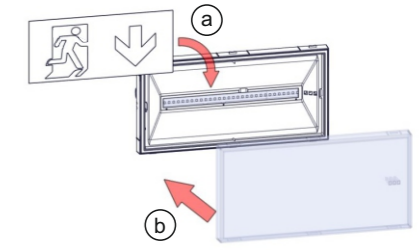

2

Mounting Methods

Sky Line luminaires can be surface mounted on walls or ceilings. For these mounted installations, special accessories are included.

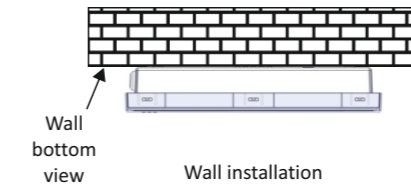

Wall installation

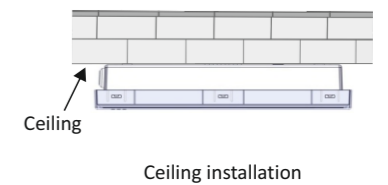

Ceiling installation

Extra Mounting and Marking Methods *

* ATTENTION!!! The below mounting methods and markings can be done after request of the necessary accessories!!

Suspended installation with A-1000 accessory
 The luminaire can be installed in a suspended ceiling.

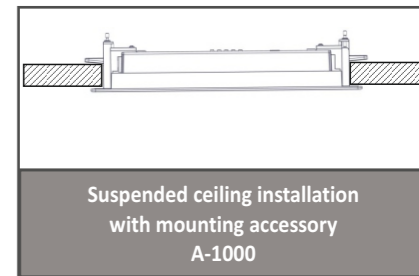

Suspended ceiling installation with mounting accessory A-1000

A marking panel (SP-1000) can be installed on the luminaire pointing the desired direction.

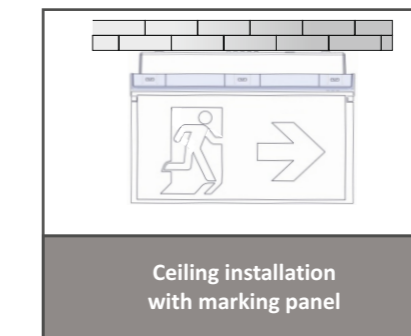

Ceiling installation with marking panel

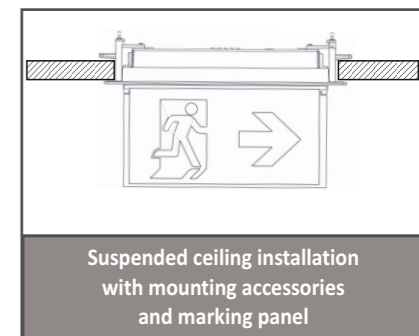

Suspended ceiling installation with mounting accessories and marking panel

Battery Replacement

It can be done only by a competent person and after the mains interruption.

- Follow step 1 of the installation instructions and remove the diffuser.
- Follow step 2 of the installation instructions and remove the reflector.
- Remove the old battery and place a new one of the same type and characteristics.
- Replace the removed parts (previous steps 1 and 2).