



BSR-2104/MAR, BSR-2114/MAR

**Addressable fire detection panel
with 2 or 4 loops and expansion
capabilities**



Operation and installation manual



for a safer world

Date	9/7/2018
File	BSR-2114/MAR
Document Number	921211401_09_002
Page	2 από 74

Contents

1 Introduction section	7
1.1 Description	7
1.2 Safety	7
1.3 Indicators and controls	7
1.3.1 Panel front	8
1.3.2 Panel Keypad	8
1.3.3 Event Indication LEDs	9
1.3.4 Zone indicators	9
1.3.5 Thermal printer	10
1.3.6 General LCD indications	11
2 Function Section 12	
2.1 Operation modes of the panel	12
2.2 Quiescent state	12
2.2.1 Language selection	13
2.3 Alarm state	14
2.4 Pre-alarm state	15
2.5 Fault state	16
2.6 Access Level 1 functions	17
2.7 Access Level 2 (User Functions)	17
2.8 Access levels 3 and 4 (Technical function)	17
3 Installation instructions	18
3.1 General Description	18
3.2 Safety	18
3.3 Description of the panel's interior	19
3.3.1 Loop board	20
3.3.2 Input/Output board	20
3.4 Connections	22
3.4.1 Connecting the mains power 230V AC	22
3.4.2 Battery connections	23
3.4.3 Connecting points to the loop	24
3.4.4 Connecting the sirens	25
3.4.5 Connecting panels to a network	26
3.4.6 Connection panel with repeaters	27
3.4.7 Fire alarm routing and fire protection connections	27
3.4.8 Fault routing connection	28
3.4.9 Various other connections	28
3.5 Calculating the loop consumption and the required cable cross section	29
3.6 Cabling	31
3.7 Mounting	32
3.7.1 Installing a loop to the panel	32
4 User Menu Section 33	
4.1 Access Codes	34
4.2 User Menu	34
4.2.1 Enable - Disable menu	37
4.2.2 Properties menu	37
4.2.3 Date - Time menu	40
4.2.4 Show Disabled Segments menu	41
4.2.5 Show zones under test	41
4.2.6 Point for service menu	42
4.3 Event menu	43
4.4 Data menu	47
4.4.1 Sending data to the PC	49
4.4.2 Receiving data from a PC	50
4.5 Information menu	51
5 Technicians menu section	55
5.1 Access Codes	55
5.2 Technician menu	55
5.3 Check menu	56
5.3.1 Check - points menu	57
5.3.2 Check Zones	57
5.3.3 Check - Auxiliary relay menu	58



for a safer world!

Date	9/7/2018
File	BSR-2114/MAR
Document Number	921211401_09_002
Page	3 από 74

5.3.4	Check - Siren menu-----	59
5.3.5	Check network-----	59
5.3.6	Extension check-----	59
5.4	Setup menu-----	60
5.4.1	Setup - Points-----	60
5.4.2	Setup - Sirens-----	64
5.4.3	Setup - Aux relay-----	65
5.4.4	Task setup-----	65
5.4.5	Setup - Groups-----	66
5.5	System menu-----	67
5.5.1	Automatic Point detection-----	67
5.5.2	Network detection-----	69
5.5.3	Extension detection-----	69
5.5.4	Initialize names-----	69
5.5.5	Factory defaults-----	69
5.5.6	Initialize alarm counter-----	69
5.6	Parameters menu-----	70
5.6.1	Network setup-----	70
5.6.2	Mode repeater-----	71
6	Technical characteristics section-----	72
6.1	Factory defaults-----	72
6.2	Option of EN 54-2-----	72
6.3	Characteristics-----	73



for a safer world

Date	9/7/2018
File	BSR-2114/MAR
Document Number	921211401_09_002
Page	4 από 74

Diagram index

Figure 1-1 Face of the panel	8
Figure 1-2 Panel keypad	8
Figure 1-3 Indication LEDs	9
Figure 1-4 LCD indications	11
Figure 2-1 System in quiescent state	12
Figure 2-2 Language selection	13
Figure 2-3 Typical screen layout during the alarm state	14
Figure 2-4 Screen layout and indications during the pre-alarm state	15
Figure 2-5 Screen layout and indications during the fault state	16
Figure 2-6 Access Level 1 functions	17
Figure 2-7 User Functions	17
Figure 3-1 Panel Interior	19
Figure 3-2 Loop board	20
Figure 3-3 Input/Output board	21
Figure 3-4 Input/Output board terminal blocks	21
Figure 3-5 Connecting the panel with 230VAC	22
Figure 3-6 230VAC connection terminal	22
Figure 3-7 Connecting batteries in series	23
Figure 3-8 Battery mounting	23
Figure 3-9 Connecting points to the loop	24
Figure 3-10 Connecting a sensor base to a loop	25
Figure 3-11 Connecting sirens to the panel	25
Figure 3-12 Connecting panels to a network	26
Figure 3-13 Repeaters connection	27
Figure 3-14 Fire Alarm Routing and Fire Protection connection	27
Figure 3-15 Fault warning routing connection	28
Figure 3-17 Connecting an automatic dialer to the panel	29
Figure 3-18 Calculating loop consumption with a PC	30
Figure 4-1 Main screen	33
Figure 4-2 Menu	33
Figure 4-3 Menu diagram	34
Figure 4-4 User Code	35
Figure 4-5 User Menu	35
Figure 4-6 User menu diagram	36
Figure 4-7 Activation Menu	37
Figure 4-8 Point properties	38
Figure 4-9 Functions	39
Figure 4-10 Group	39
Figure 4-11 Working hours menu	40
Figure 4-12 Working days menu	40
Figure 4-13 Disabled sections	41
Figure 4-14 Sensor due for maintenance	42
Figure 4-15. Main screen in quiescent state	43
Figure 4-16 Menu	43
Figure 4-17 Event menu	44
Figure 4-18 Events menu diagram	44
Figure 4-19 Viewing events	46
Figure 4-20 Computer software	47
Figure 4-21 Port settings	48
Figure 4-22 Data menu	48
Figure 4-23 Data menu diagram	49
Figure 4-24 Establishing communications	49
Figure 4-25 Sending data to a PC	50
Figure 4-26 Data transfer	50
Figure 4-27 Information menu	51



for a safer world!

Date	9/7/2018
File	BSR-2114/MAR
Document Number	921211401_09_002
Page	5 από 74

Figure 4-28 Information menu diagram.....	51
Figure 4-29 System information	52
Figure 4-30 Loop information	53
Figure 4-31 Loop information	53
Figure 4-32 Technician information.....	54
Figure 5-1 Access code for level 3.....	55
Figure 5-2 Technicians menu.....	55
Figure 5-3 Technicians menu diagram	56
Figure 5-4 Point Testing	57
Figure 5-5 Auxiliary relay testing.....	58
Figure 5-6 Activating the output	58
Figure 5-7 Siren testing.....	59
Figure 5-8 Network check	60
Figure 5-9 Point configuration.	61
Figure 5-10 Selecting the type of point	62
Figure 5-11 Changing the name of a point	62
Figure 5-12 Changing the status of a point.....	63
Figure 5-13 Siren configuration	64
Figure 5-14 Auxiliary relay configuration.....	65
Figure 5-15 Function configuration	66
Figure 5-16 Group configuration.....	67
Figure 5-17 Automatic point detection	68
Figure 5-18 Point with the same address.....	68
Figure 5-19 End of point recognition.....	69
Figure 5-20 Network setup	70
Figure 5-21 Repeater mode	71



 olympia electronics <small>SAFETY & SECURITY SYSTEMS</small> <i>for a safer world!</i>	Date	9/7/2018
	File	BSR-2114/MAR
	Document Number	921211401_09_002
	Page	6 από 74

Table index

Table 3-1 Device consumptions.....	29
Table 3-2 Loop cable length	30
Table 3-3 Siren cable length (Alarm)	31
Table 6-1 Factory default settings	72
Table 6-2 Options with requirements EN 54-2 including in the panel.....	72
Table 6-3 Characteristics.....	73

 	Date	9/7/2018
	File	BSR-2114/MAR
	Document Number	921211401_09_002
	Page	7 από 74

1 Introduction section

Thank you for purchasing this product of Olympia Electronics. A European manufacturer. This section contains general information about the panel and its use. It must be read carefully by all the **users of the panel** so that they can act accordingly in the event of a fault or alarm condition.

1.1 Description

The **BSR-2104/MAR** and **BSR-2114/MAR** are used on ships and there are 2 or 4 loop addressable fire detection panels with expansion capabilities that can upgrade the panel to 8 loops.

The maximum number of loops connected must not exceed 4.

The panels is designed and constructed according to EN54-2 and EN54-4 regulations.

Each loop can accept up-to **150** total points, which can be input units (detectors, call points), output units and line isolators.

The maximum number of fire detectors and manual call points connected to a panel must not exceed 512.

All units that are connected to the loop are referenced and displayed on the LCD panel with the general term «POINTS» and in this term we will be referred to throughout this manual. Each point has a specific address ranging from **1 to 150** in each loop. Each loop can accept various types of points. We will refer to these points later on in the manual.

The panel has 96 zones and is suitable for larger installations such as malls, shopping centers, hotels and factories.

It offers an extensive selection of settings and options for controlling the equipment and sirens of the installation which can easily be modified using PC based software.

The panels programming can also be done using a PC.

1.2 Safety

A device is not considered that it is being used correctly if the accompanying documents are not read prior to its use. This product must be installed, commissioned and maintained by qualified technical personnel according to:

- Regulations referring to installing electrical devices in buildings.
- Practice rules.
- The statutes requirements.
- The manufactures instructions.

- The unit operates with 220-240VAC / 50-60Hz and is rated as a class1 device (**requires a grounding wire for safe operation**).

- It must be installed and connected to the power line using it's own safety fuse with a warning label «**Fire detection system - Do not isolate**».

1.3 Indicators and controls

The panel contains a big 320x240 pixel LCD screen which is used to display messages whereas the indications LEDs are used to show basic warnings (alarm, fault, isolated sections).

The fascia of the panel also contains a 16 button keypad used for controlling the system.

Generally we can see:



1.3.1 Panel front

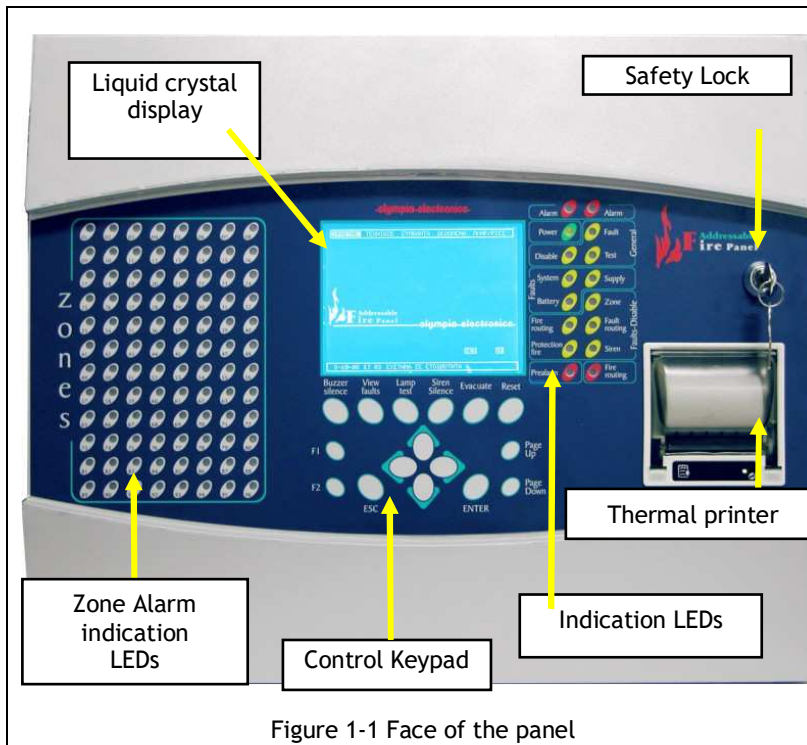

Figure 1-1 Face of the panel

The panel's fascia contains the LCD and an assortment of LEDs, that are used to relay information to the user concerning the status of the system. The LEDs provide us with general information (e.i. If we have an alarm then the LED General Alarm is lit) and the LCD shows additional information for each event (i.e. alarm 1, from point 120, which belong to zone 10 and took place on 09/01/2007 and at 14:07) .

Bellow the LCD there is an array of 16 buttons that are used to control the panel. These buttons correspond to the basic functions of the panel such as, the navigation keys for navigating left, right, up and down, the enter key for making selections and the escape key for exiting or going to the previous menu level. (see below for more information).

In general, a key can either invoke an action or can present a menu with an assortment of selections that are used to control the panel. (see paragraph 1.3.2).

The panel also has a safety lock and a thermal printer mounting point (see figure. 1-1).

1.3.2 Panel Keypad

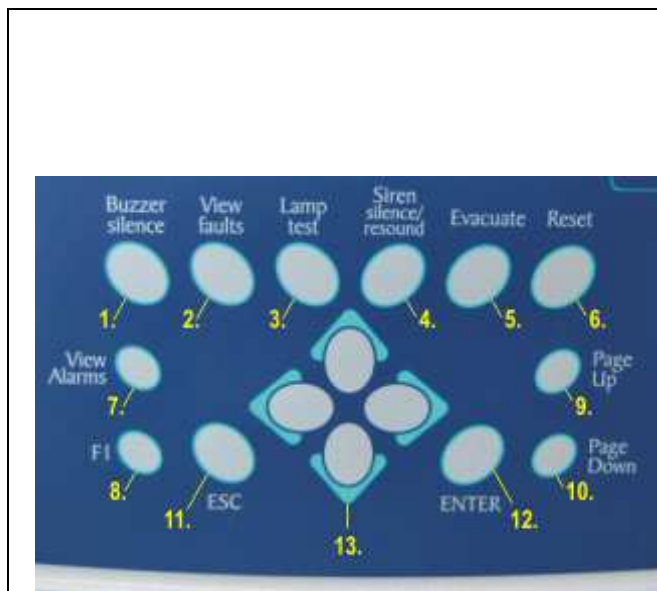

Figure 1-2 Panel keypad

1.	Buzzer Silence	Stops the internal buzzer.
2.	View Faults	Shows current fault events if available.
3.	Lamp Test	Pressing this button will light all the indication LEDs in order to verify there good operation.
4.	Siren Silence/Resound	In case of a fire event we can silence /resound the sirens by pressing this button (Access Level 2)
5.	Evacuate	Evacuation button (Access Level 2)
6.	Reset	System reset.
7.	Page Up	Return to the previous page-level or increase the counter by 10
8.	Page Down	Go to the next page-level or decrease the counter by 10
9.	View Alarms	Shows current alarms events if available.
10.	F1	Auxiliary key F1. Its function is programmable from the panel.
11.	Esc	Go to the previous level-Exit.
12.	Enter	Accept selection.
13.	(U/D/R/L)	Menu navigation (up / down/ left / right) - Or cursor position. The keys up and down can also be used to increase or decrease a counter.



1.3.3 Event Indication LEDs

The Leds are separated in groups and are color coordinated. This helps us understand there functions easily. In detail, the indications of the Leds correspond to the following instances:

	1.	Alarm [red]		The system is in an alarm status
	2.			
	3.	Power [green]		General panel operation indicator.
	4.	General [yellow]	Fault	In the event of a fault
	5.		Disable	General disablement indicator
	6.		Test	In the event of a test condition
	7.	Faults [yellow]	System	During a malfunction of the panels pcbs
	8.		Supply	In case of a power line failure
	9.		Battery	During a problem with the battery
	10.	Fault - Disable [yellow]	Zone	Blinks during a zone error. Stays always on to indicate disabled zones.
	11.		Fire routing	Blinks to indicate an alarm signal error. Stays always on to indicate a disabled signal.
	12.		Fault routing	Blinks to indicate a fault signal error. Stays always on to indicate a disabled signal.
	13.		Protection fire	Blinks to indicate a extinguishing signal error. Stays always on to indicate a disabled signal.
	14.		Siren	Blinks to indicate a siren error. Stays always on to indicate disabled sirens.
	15.	[yellow]	Prealarm	Pre Alarm indicator.
	16.	[red]	Fire routing	Alarm system activation.

Figure 1-3 Indication LEDs

1.3.4 Zone indicators

	<p>The panel offers 96 - in correspondence with the zones - indicator LEDs which light in case of an alarm. Each LED corresponds to one zone.</p>
--	---



1.3.5 Thermal printer

The thermal printer is optional and can be installed on any panel.

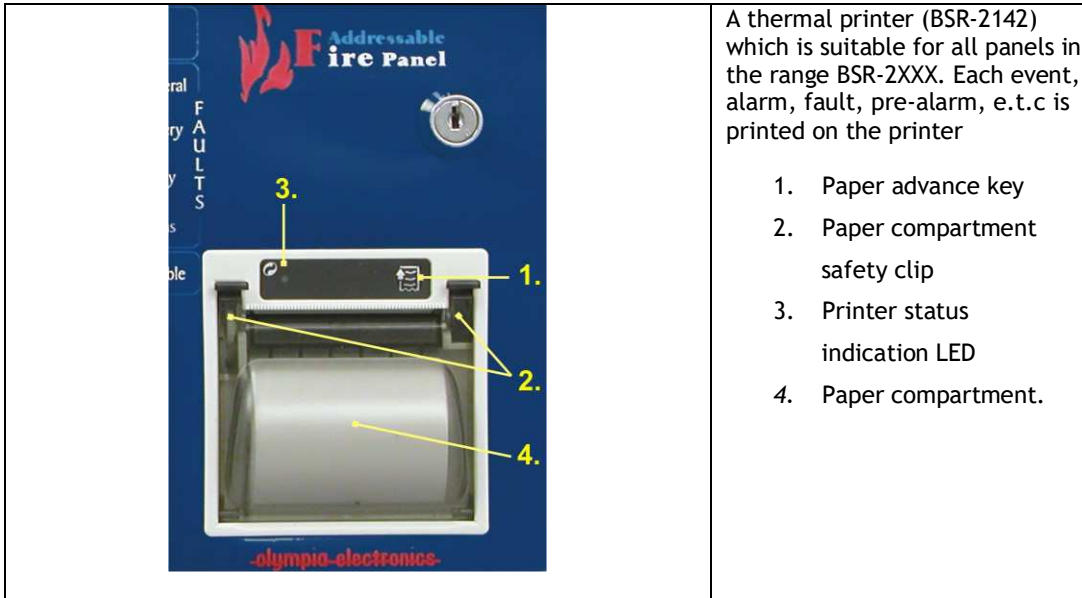

To advance the paper press the button (1.) located on the top right side of the printer

When the printer is connected correctly then the green LED (3.) is ON

When the green LED (3.) is blinking then there is no paper

Changing the paper is simple. Press the two safety clips (2.) and open the paper compartment (4.) to insert the paper.

WARNING! The printer is a thermal printer which uses special thermal paper.

WARNING! The paper must be installed in such a way that the external side of the paper role is facing the LED, otherwise it will not print.



1.3.6 General LCD indications

The figure below shows the general indications of the panels LCD display.

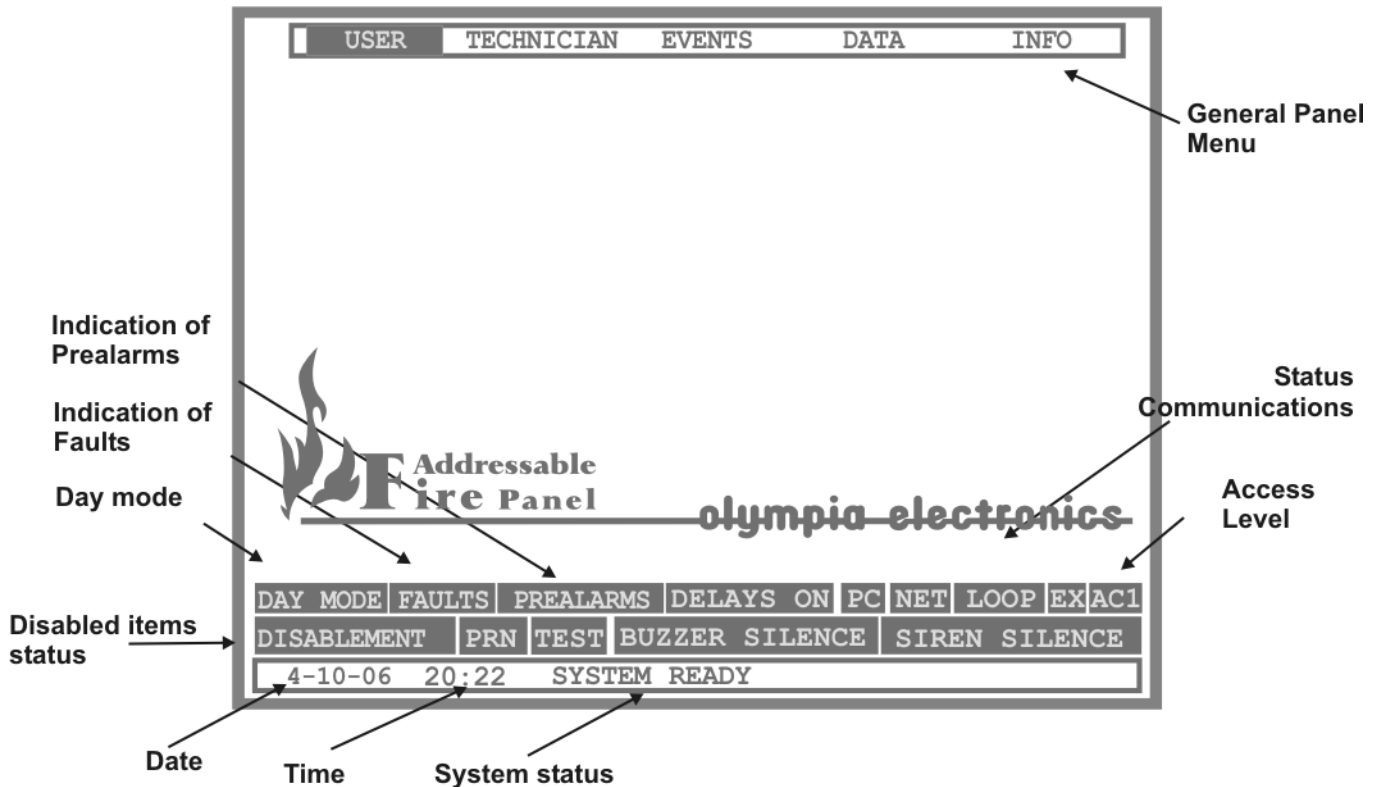

Figure 1-4 LCD indications

While in the waiting screen, press the «ENTER» key to show the main menu on the top section of the screen. The last line of the screen shows the date, time as well as the general state of the panel. The bottom section of the screen shows some icons that show useful information about the panel's status to the user of the panel. This information is:

- «DAY MODE» : This indication shows that all sensors have the day setting and not the night.
- «FAULTS» : This indication shows that there are faults in the system. (Pressing View Faults, shows the fault).
- «PREALARMS» : When this indication is shown then there are pre-alarms in the system.
- «DELAYS ON» : When a delay of an output is activated.
- «PC» : During this indication there is a communication between the panel and a PC.
- «NET» : During this indication the network protocol of the panel is active.
- «LOOP» : This indication is used to show that the loops are in operation.
- «EX» : This indication shows that the expansion protocol of the panel is active.
- «AC1» or «AC2» or «AC3»: This indication shows the access level state that we are in.
- «DISABLEMENT» : This indicator shows that there are disabled sections in the panel.
- «PRN» : This indication shows that there is a printer which is activated to print immediately.
- «TEST» : When the panel is in test condition.
- «BUZZER SILENCE» : This indicator shows that the buzzer has been silenced.
- «SIREN SILENCE» This indication shows that there are sirens that have been silenced (except for the sirens that have been set differently (see. Siren parameters)).



2 Function Section

2.1 Operation modes of the panel

Below we will describe the indications that are shown on the LCD during the following states of the panel:

A) Quiescent state

B) Alarm

C) Pre Alarm

D) Fault

2.2 Quiescent state

The state where there is no alarm, pre-alarm or a fault condition is called the quiescent state. The LCD will be approximately identical to the figure below:

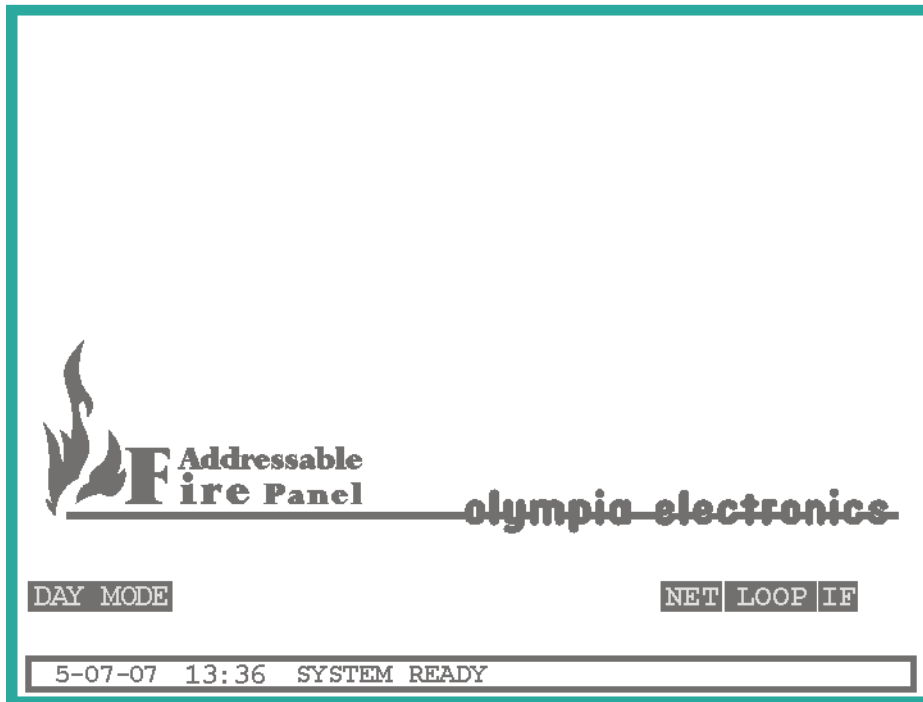



Figure 2-1 System in quiescent state

From the indication LEDs only the power LED should be lit.

Note. If there is a disabled section then the corresponding LED will be lit and the indication «DISABLED SECTIONS» will be shown.

  <p><i>for a safer world!</i></p>	Date	9/7/2018
	File	BSR-2114/MAR
	Document Number	921211401_09_002
	Page	13 από 74

2.2.1 Language selection

When the panel is in quiescent state then the language can be changed by pressing the «ESC» key. After pressing the key the following language selection screen is shown:

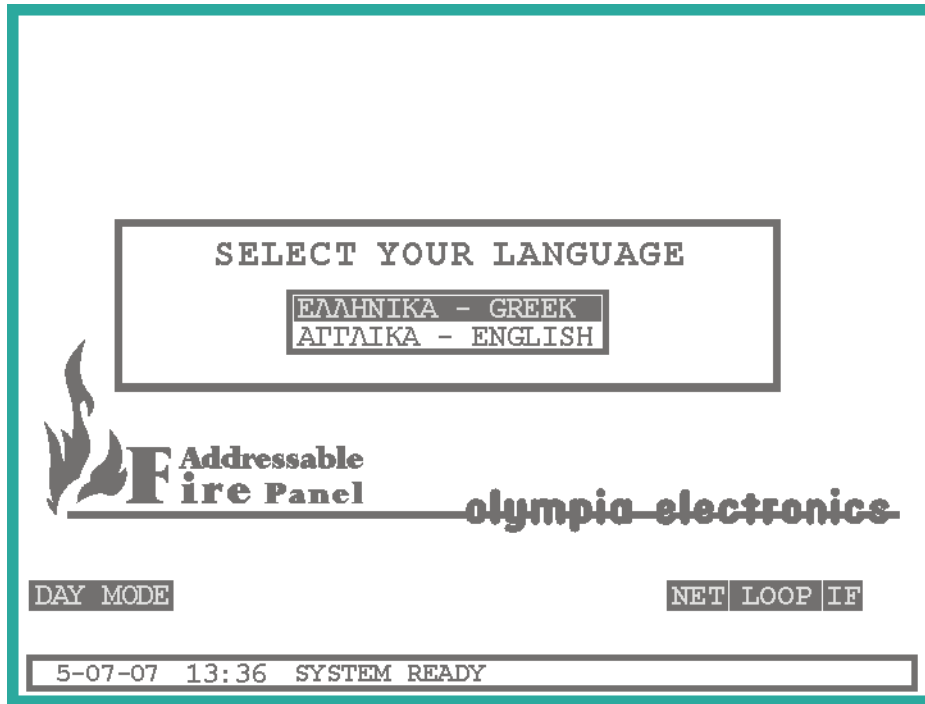

Figure 2-2 Language selection

Using the «UP» and «DOWN» keys select the desired language and press the «ENTER» key to confirm.



2.3 Alarm state

When a device gives a fire alarm signal the red LED marked “General Alarm” lights. The LCD will show information concerning the address on the point that issued the alarm as shown in the figure below:

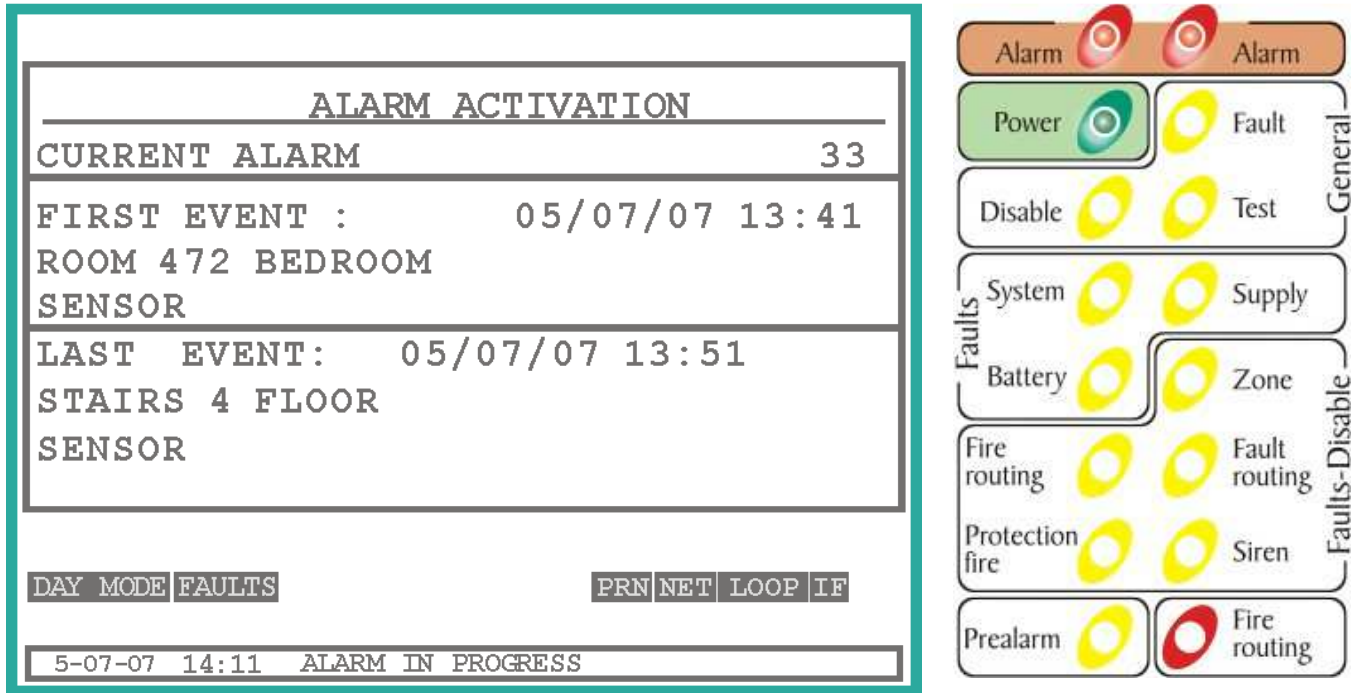

Figure 2-3 Typical screen layout during the alarm state

The total number of alarm events (Alarm counter) is shown to the right of the window title. The screen is divided into 2 sections. The upper section shows the first alarm event along with the date 05/07/07, time 13:41, name of the point that issued the alarm and finally the type of point. The lower section shows the last alarm event that took place.

When an alarm is issued, the internal buzzer will sound periodically and all the units that are connected with the alarm will be activated. If you want to stop the buzzer, press the «Buzzer Silence» key and if you want to stop the sirens press the «Siren Silence» key.

2.4 Pre-alarm state

If a point that is connected to the loop issues a pre-alarm then the yellow LED marked “Pre-Alarm” lights. The LCD screen will show additional details about the pre-alarm.

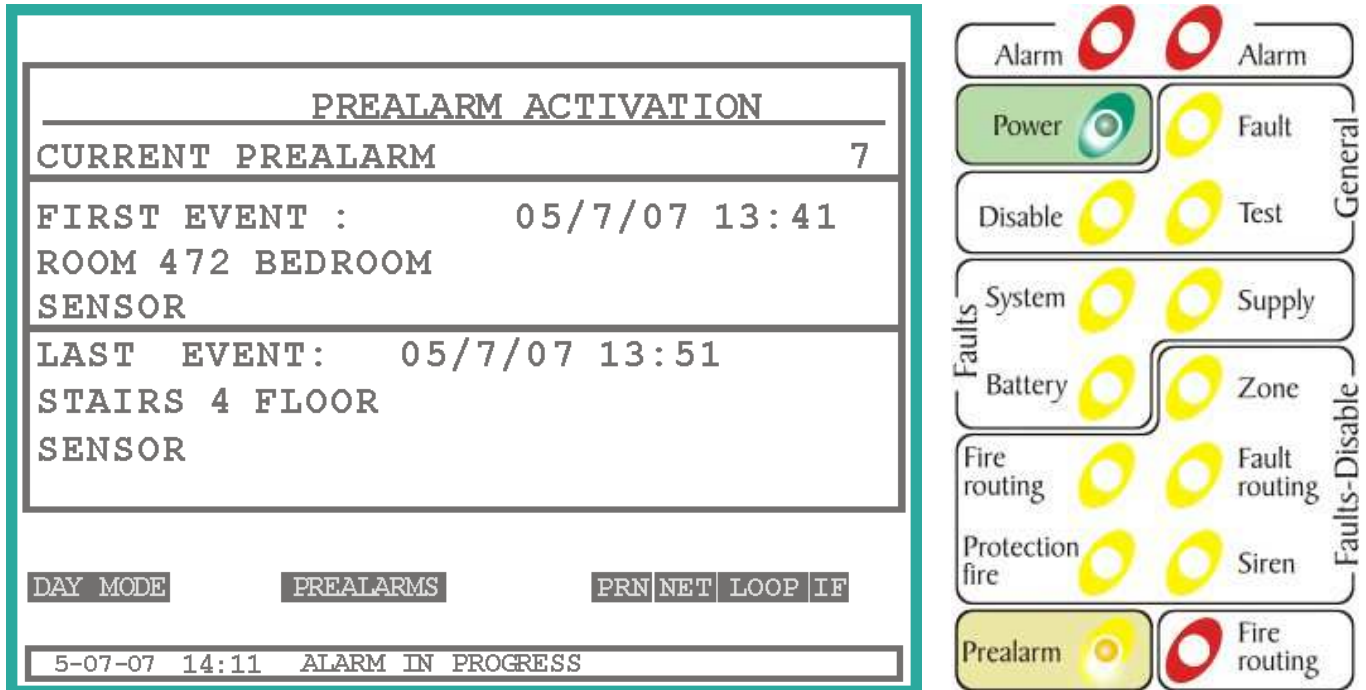

Figure 2-4 Screen layout and indications during the pre-alarm state

The total number of pre-alarm events (**Pre-alarm counter**) is shown to the right of the window title. The screen is divided into 2 sections. The upper section shows the first pre-alarm event along with the date 05/07/07, time 13:41, name of the point the issued the pre-alarm and finally the type of point. The lower section shows the last pre-alarm event that took place. When a pre-alarm is issued the internal buzzer will sound periodically and all the units that are connected with the alarm will be activated. If we want to stop the buzzer we can press the “**Buzzer Silence**” key.

In order to receive a pre-alarm signal, at least one point must be configured to issue pre-alarm signals. By default no points are configured to issue pre-alarm signals. Usually we select to receive pre-alarm signals only from detectors that are installed in areas where the fire will not grow in a rapid rate.

If simultaneous alarm and pre alarm conditions occur, the LCD will show the alarm events and the indication “PREALARMS”.



Date	9/7/2018
File	BSR-2114/MAR
Document Number	921211401_09_002
Page	16 από 74

2.5 Fault state

During a fault event the LED “General Fault” is lit. Other LEDs that describe the faults origin can also be lit. The LCD will show additional details regarding the fault..

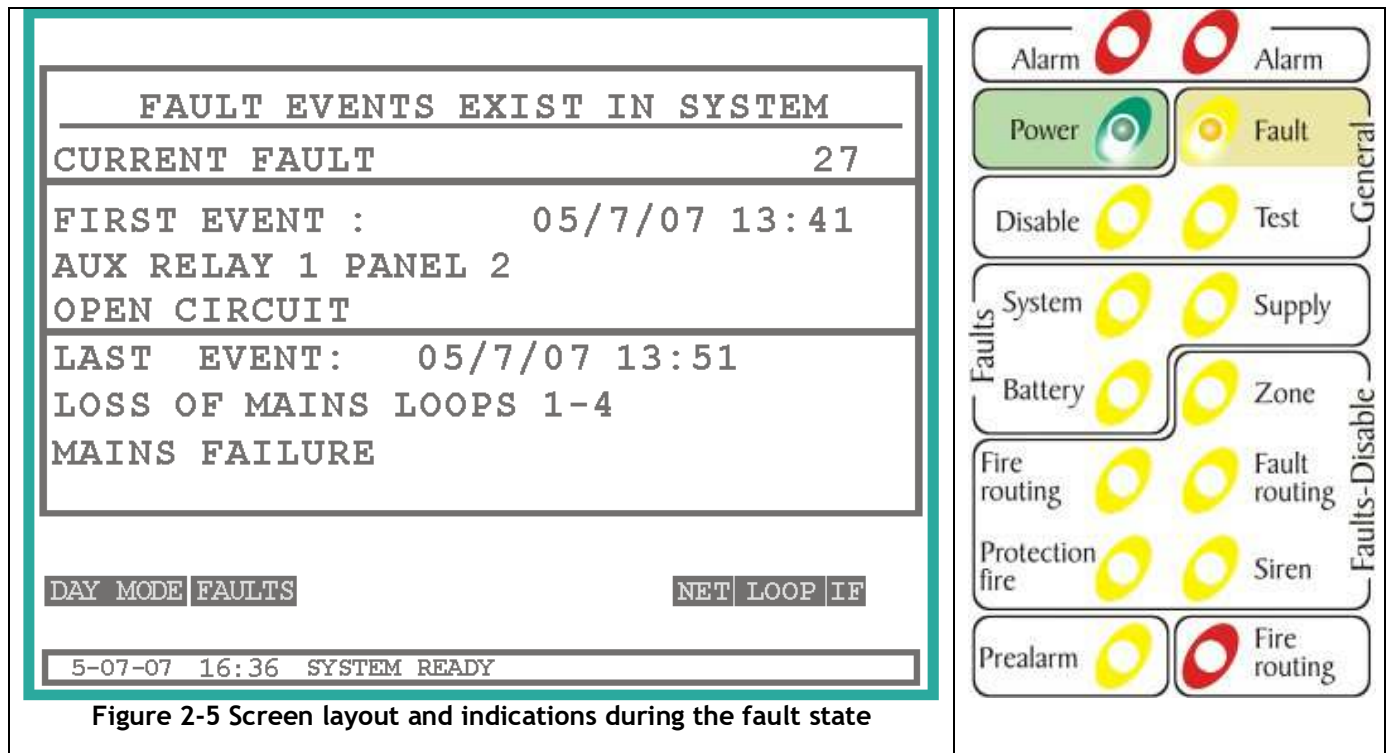

The total number of fault events (**Fault counter**) is shown to the right of the window title. The screen is divided into 2 sections. The upper section shows the first fault event along with the date 05/07/07, time 13:41, the type of fault and the description.

When a fault is issued the internal buzzer will sound periodically and all the units that are connected with the alarm will be activated. If we want to stop the buzzer we can press the “**Buzzer Silence**” key.



Date	9/7/2018
File	BSR-2114/MAR
Document Number	921211401_09_002
Page	17 από 74

2.6 Access Level 1 functions

This level contains the functions that can be implemented by a normal user.

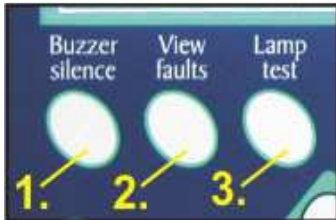

Figure 2-6 Access Level 1 functions

- **“Buzzer Silence”**: In case of an alarm, pre-alarm or fault and if button (1) is pressed then the internal buzzer will stop. The buzzer sounds every 30 seconds for all the duration of the event. If in this state the panel recognizes a new event then the buzzer starts to sound.
- **“View Faults”**: Pressing this button when a fault condition is active will permit us to see the current fault events. We will present this option in detail in the next paragraph.
- **“Lamp Test”**: When the panel is in normal operation with no alarm, pre-alarm or fault condition then by pressing this button (3) we can conduct a lamps test which will light all the leds and the display in order to verify for good operation.

2.7 Access Level 2 (User Functions)

This level contains all the functions that are required by the user of the system during an alarm, pre-alarm or fault condition. These functions should be available only to the person that is responsible for the fire protection of the building. The functions available by pressing a button are shown below.

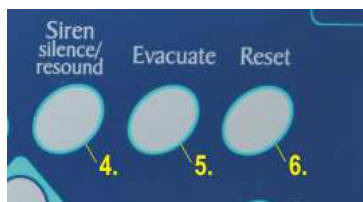

Figure 2-7 User Functions

- **«Siren Silence/ Resound”**: Press this key to stop or resound the sirens during and alarm event.
- **“Evacuate”**: Press this key to issue and evacuation condition.
- **“Reset”**: Using this key permits us to reset the system.

In order for the above function to take place, the access level 2 code must be inserted

Access level 2

TYPE IN YOUR CODE -----

2.8 Access levels 3 and 4 (Technical function)

Technical functions are done using the menu and will be described in detail in section 5.

 	Date	9/7/2018
	File	BSR-2114/MAR
	Document Number	921211401_09_002
	Page	18 από 74

3 Installation instructions

This section contains information regarding the connection of the panel with its peripherals, the programming of all the functions and the elimination of the faults. It should be read carefully by all the installers who want to install and commission a fire detection system. A good knowledge of the panel's capabilities and its peripheral devices is an essential aid in designing an operable installation.

3.1 General Description

The BSR-2104/MAR and BSR-2114/MAR panels are addressable fire detection panels with 2 or 4 loops and expansion capabilities up-to 8 loops and 32,64 or 96 zones. Each loop can accept up-to 150 input units (sensors, call points) , output units and line isolators.

The maximum number of fire detectors and manual call points connected to a panel must not exceed 512.

All units can be programmed to correspond to a specific zone without any device per zone limitations. Each point must have its own individual address which is set using micro switches on each unit. The instruction manual of each unit shows in detail the position of each micro switch that corresponds to each address.

The peripherals that can be connected to a loop of the panel are the following:

- BSR-6055/A/MAR. Addressable smoke detector.
- BSR-6057/A/MAR. Addressable smoke detector/heat detector.
- BSR-6060/A/MAR. Addressable heat of rise detector.
- BSR-5036/A/MAR. Addressable call point.
- BSR-8017/MAR. Addressable input/output unit with auxiliary relay.
- BSR-5032/MAR. Addressable siren with beacon.
- BSR-5032/WP/MAR. Waterproof Addressable siren with beacon.
- BSR-7070/A/MAR. Addressable line isolator. (Does not register as point in the panel and does not require an address) .
- BSR-7071/A/MAR. Addressable line isolator. (Does not register as point in the panel and does not require an address) .

On the siren outputs of the unit we can connect all the conventional sirens (BS-531/MAR, BS-531/WP/MAR).

All addressable detectors have a remote led output.

In order to minimize the errors during the installation and programming stages it is mandatory to have a general plot or diagram. On the diagram we mark the address of each point, the name that it will be given (up to 32 characters) and that zone that it will belong too.

The panel can be programmed and commissioned by using the built in keypad.

According to regulations, it is mandatory that during a loop short circuit, not more that 32 detectors will fail. To comply to this, it is required that a line isolator is placed after every 32 detectors or points.

3.2 Safety

A device is not considered that it is being used correctly if the accompanying documents are not read prior to its use. This product must be installed, commissioned and maintained by qualified technical personnel according to:

- Regulations referring to installing electrical devices in buildings
 - Practice rules.
 - The statutes requirements.
 - The manufactures instructions.
- The unit operates with 220-240VAC / 50-60Hz and is rated as a class1 device (**requires a grounding wire for safe operation**).
- It must be installed and connected to the power line using its own safety fuse with a warning label «**Fire detection system - Do not isolate**».



3.3 Description of the panel's interior

The interior can be accessed by disengaging the lock found on the right of the panel.
In general, the panel consists of 2 sections:

1. The left internal section contains the main processor board, the zone indicators, the printer mounting area and the lock of the cover.
2. The right internal section contains the power supply, the loop board, the input/output board, the battery compartment, the mounting holes as well as the cable inputs.

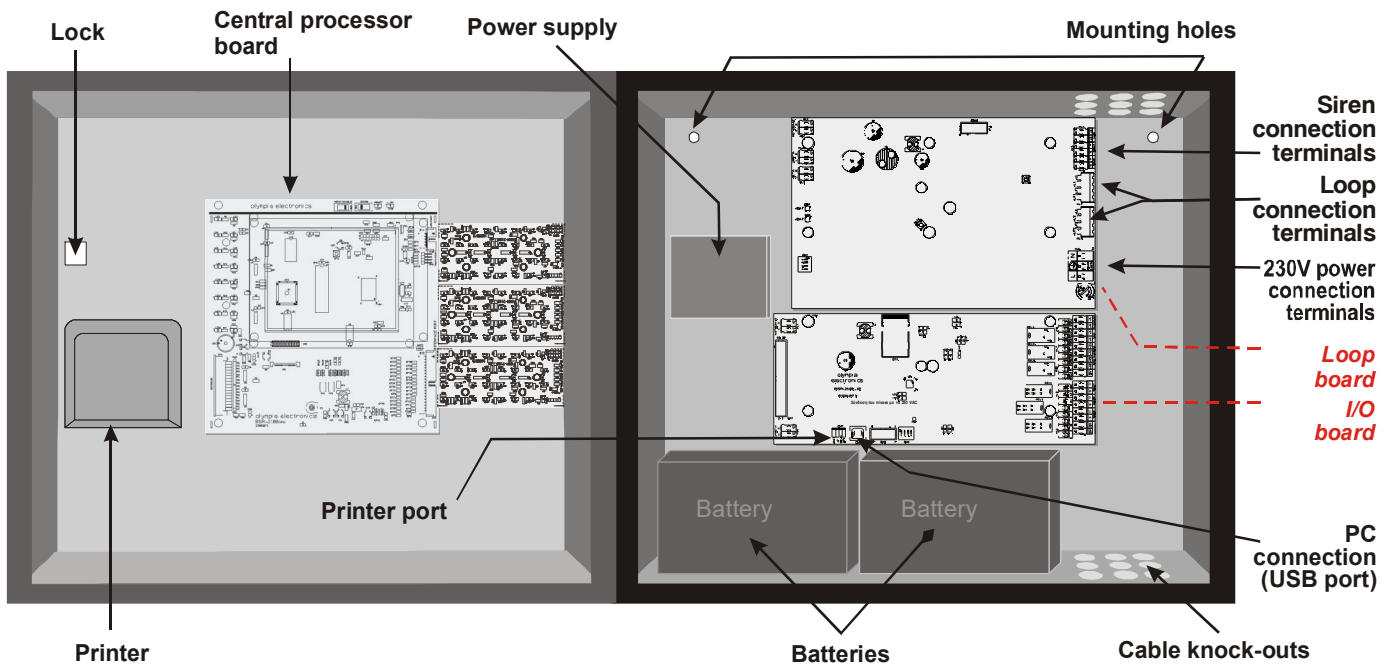

Figure 3-1 Panel Interior



3.3.1 Loop board

This board is located on the top right section of the panel.

In general it contains terminals for connecting the panel power supply, for connecting sirens, for connecting the loops and for connecting the mains power supply.

The diagram below shows the connection terminal blocks of the board.

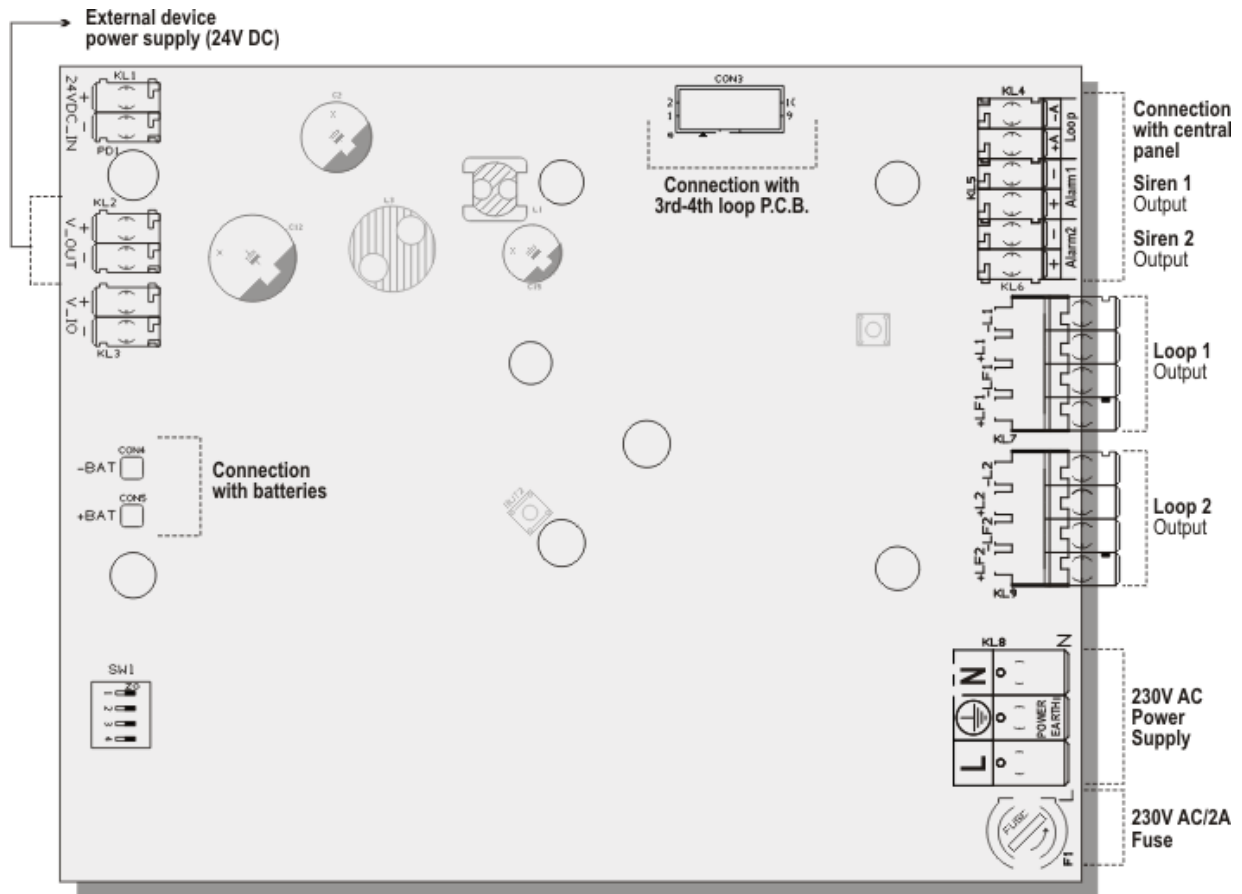

Figure 3-2 Loop board

3.3.2 Input/Output board

This board is located on the bottom right section of the panel and contains terminals for connecting the panel to another panel, the board with the main processor board, the printer port, the USB PC port and other external devices.



Date	9/7/2018
File	BSR-2114/MAR
Document Number	921211401_09_002
Page	21 από 74

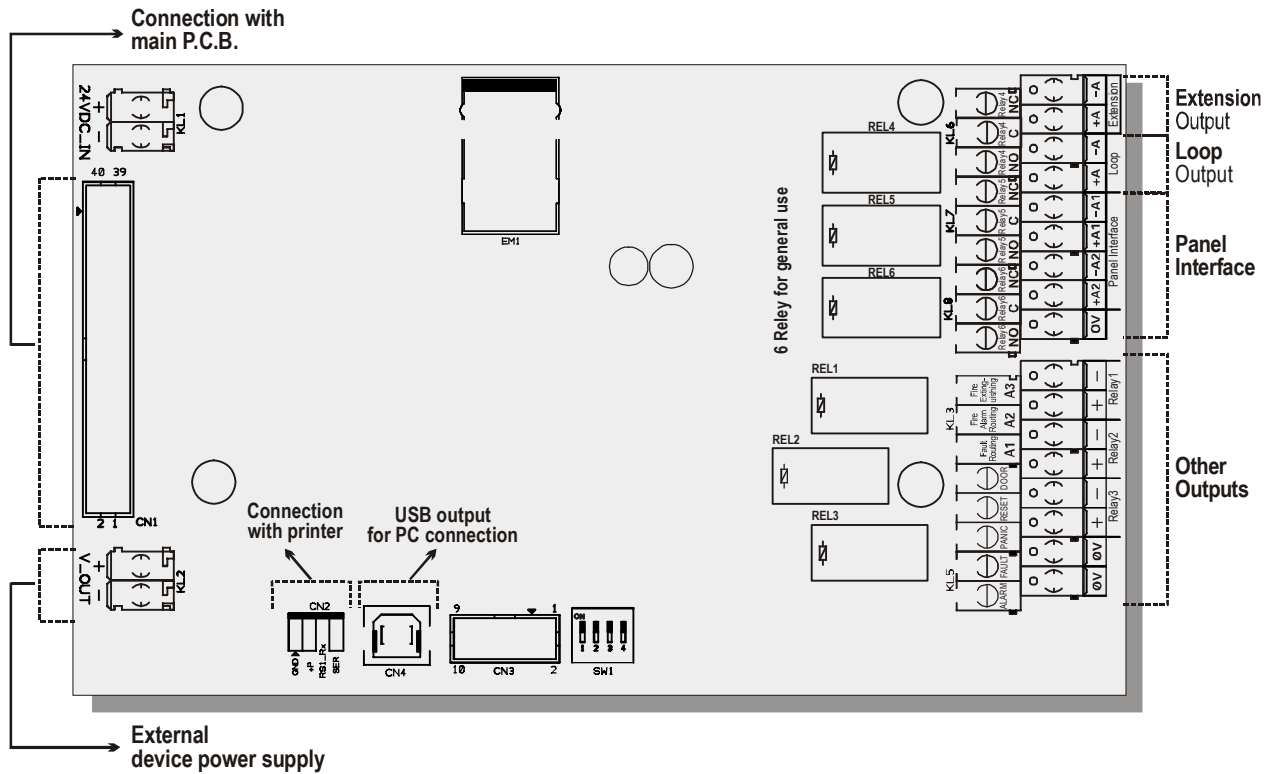

Figure 3-3 Input/Output board

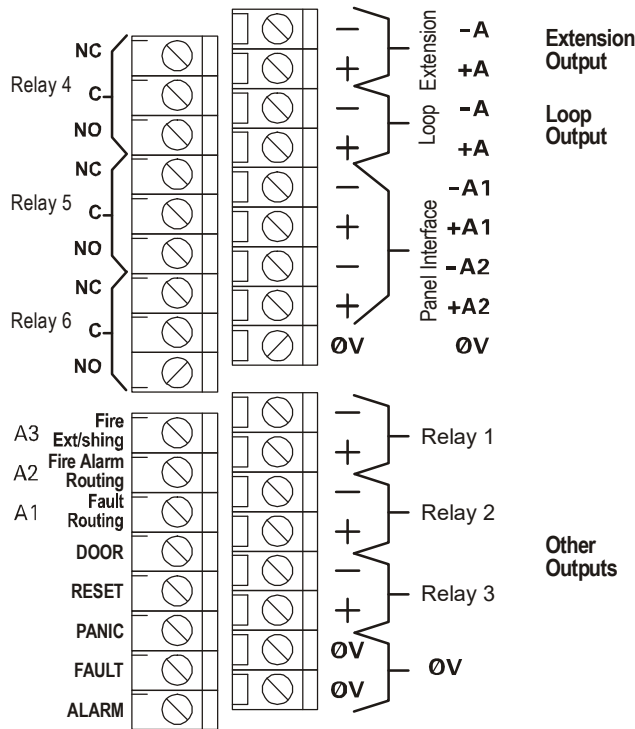

Figure 3-4 Input/Output board terminal blocks

Figure 3-4 shows the connection terminal block found on the right side of the input/output board. The paragraph below will describe in detail the function of each signal.



3.4 Connections

In the following paragraphs we will describe all the connections that can be done to the panel.

Each individual connection should have its own connection cable. (e.i. a 3 core cable for connecting the mains power supply, a 2 core cable for connecting the sirens e.t.c).

The shielding of each cable must be connected to the ground of the panel via the connection terminal blocks.

3.4.1 Connecting the mains power 230V AC

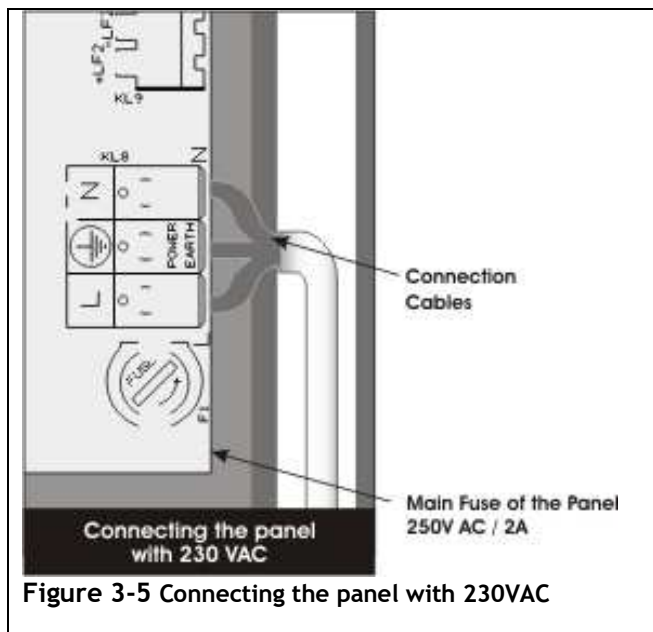

To connect the panel to the main power supply, use a cable with an external shroud.

The connection is done using the special terminals blocks located on the lower right section of the loop board as shown in figure 3-5.

Below the terminal block there is a fuse with a rating of (5x20, 2A-250VAC SLOW) which is the central fuse of the panel.

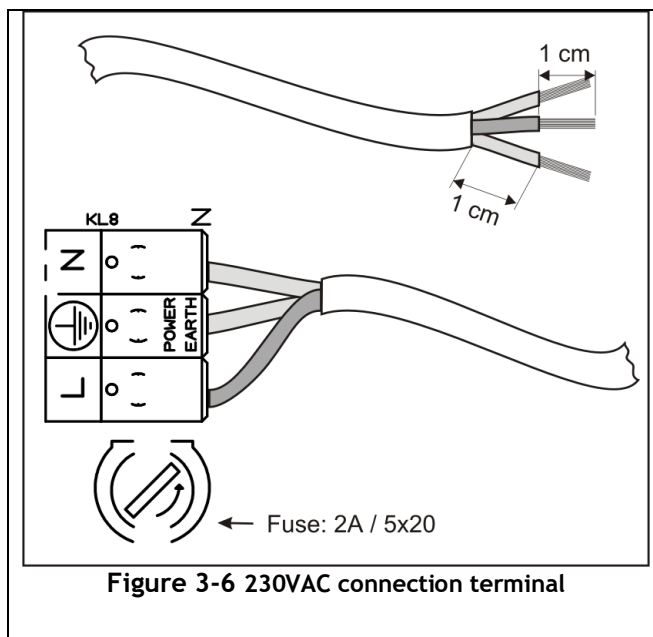

Warning!

1. During the initial setup, the connections with the 230V AC power supply and the battery should be done only after finalizing all other connections.
2. The connection with the panel should be done using a 16A protection fuse. The fuse should be marked with a label «Fire detection system - Do not isolate».
3. Always use cable with double insulation.
4. The cable cross section should be at least 1mm.
5. The internal insulation must not be removed by more than 1cm.
6. The external insulation must not be removed by more than 1cm in respect to the internal insulation.
7. The internal fuse of the panels has a rating of 2A-250VAC (SLOW BLOW) with 5x20mm dimensions.
8. The mains power supply must have a grounding cable which is connected to the grounding of the building.



3.4.2 Battery connections

The battery compartment on the lower left section of the panel as shown in figure 3-1.

The batteries used must be 2x Sunlight SP-12 12V (7Ah or 12Ah) Lead Acid with a rating of 12V each. It's capacity can range from 7Ah or 12Ah.

The battery cables originate from the loop board and are connected to the poles of the battery. The black cable-connector is connected to the negative battery pole (it is marked with a (-) or is colored black) and the red cable with white connector is connected to the positive pole (it is marked with a (+) or is coloured red).

Note. If 12V batteries are used then we can connect them in series with the help of the black connection cable (see figure 3-7).

Replace batteries with batteries of the same type and rating.

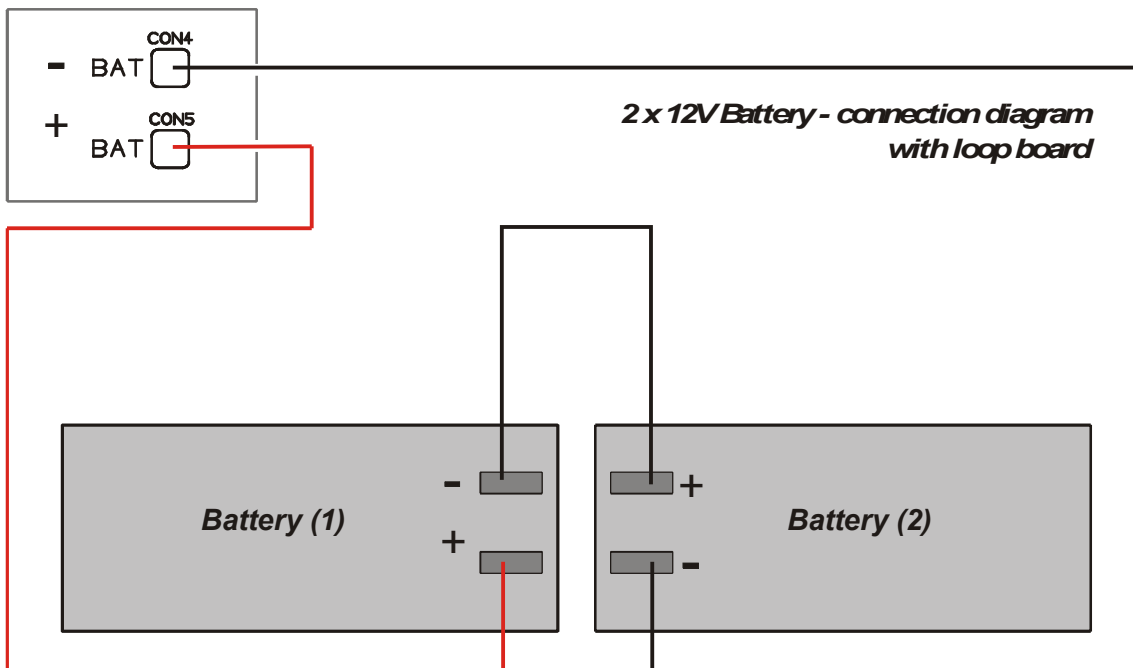

Figure 3-7 Connecting batteries in series



Figure 3-8 Battery mounting



The above picture shows how the battery mounting if the is a problem of vibration. In the package of the panel there is the metal parts and the screws for mounting the batteries. The metal brackets must be fitted at all times.

3.4.3 Connecting points to the loop

The diagram below show a typical connection between points and the loop.

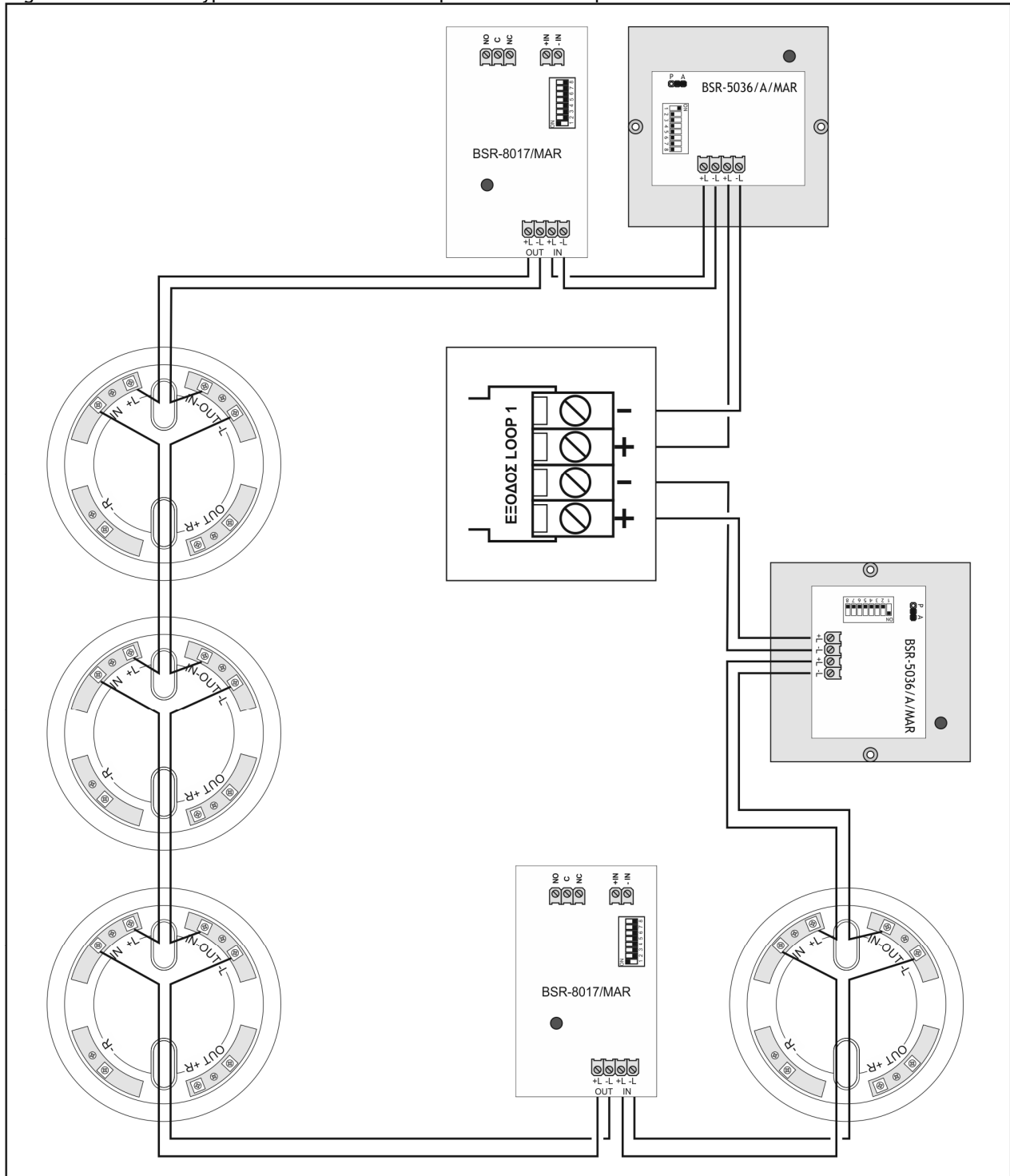

Figure 3-9 Connecting points to the loop

All compatible with the panel devices (except sensors) have 4 terminals for connection to the loop. The terminals are marked as +L, -L, +L, -L. On one pair +L and -L connect the cables of the loop that come from the panel or the previous



device and on the other pair +L and -L connect the cables to the next device. In sensors bases, connect the positive loop cable to the contacts marked as «IN» and the negative loop cable to the contacts marked as «IN-OUT». The loop must be a closed or circular circuit without any branches. Each loop circuit detects open and short-circuits conditions.

The figure below shows how a sensor base is connected to the loop as well as the connection of the external indication LED to the base. The external indication LED lights when the detector issues an alarm.

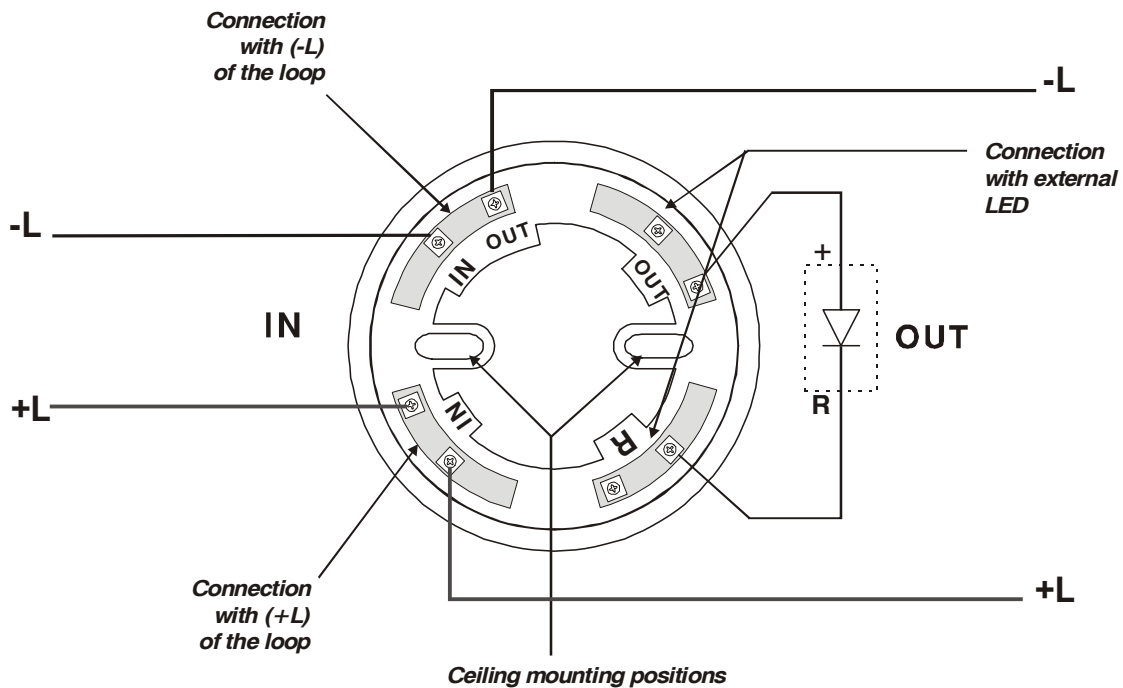

Figure 3-10 Connecting a sensor base to a loop

Warning!!! To override the delays (at access level 1) a call point must be used and this manual call point must be close to the panel (Ref Clause 7.11.1.d of EN54-2).

3.4.4 Connecting the sirens

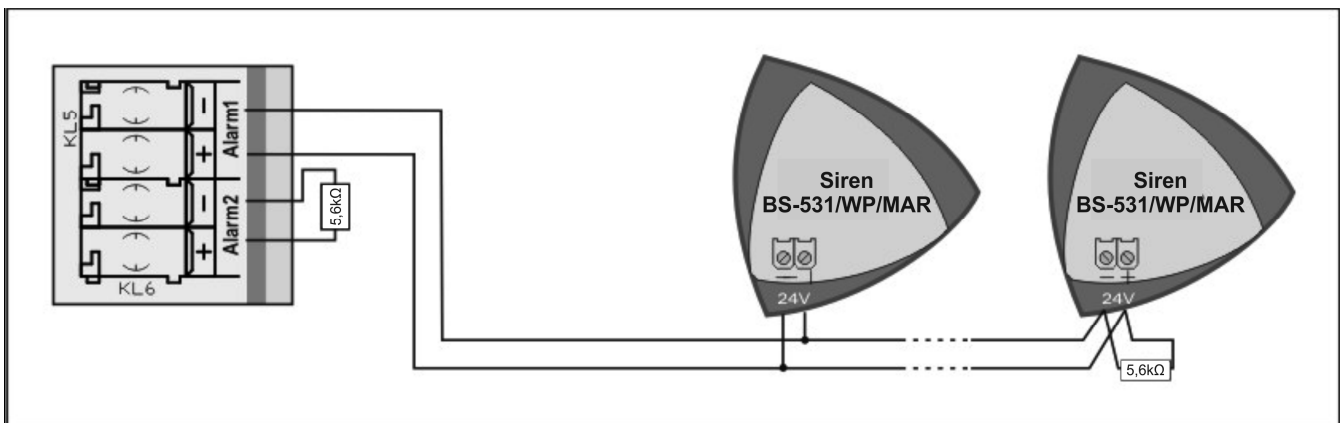

Figure 3-11 Connecting sirens to the panel

The loop board have 2 siren outputs, one per loop, that are marked as «ALARM-1» and «ALARM-2». Each output can provide up to 500mA and is monitored for open and short circuit conditions. By default there are terminals resistor (5,6KΩ) mounted on the terminals of these outputs. If an output is not used then the resistor must be left connected. If an output is used then the resistor is removed and installed in parallel with the last siren as shown in figure 3-10. By default, both siren outputs are programmed to operate in case of an alarm.



3.4.5 Connecting panels to a network

The I/O board contains four terminals (+A2, -A2, +A1 and -A1). These terminals are used to inter-connect the panels in installation where we want to install a network. The network can contain up to 32 panels.

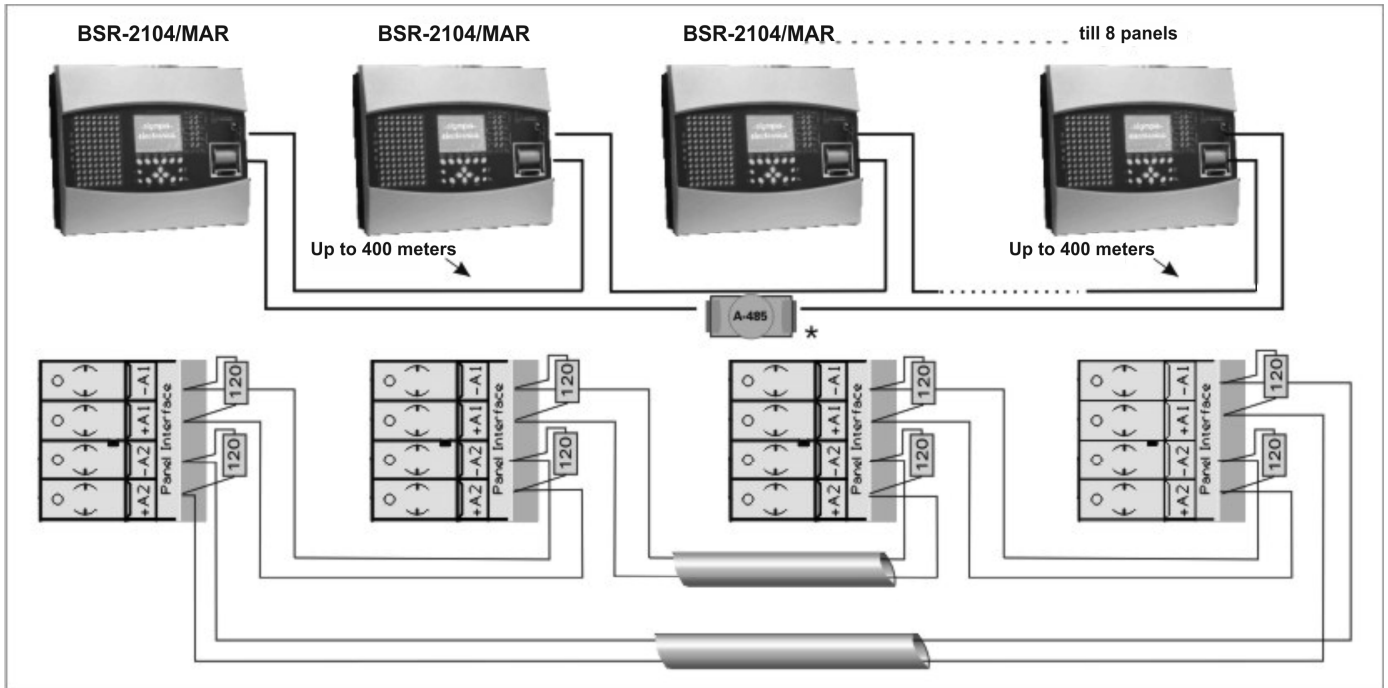

Figure 3-12 Connecting panels to a network

The maximum distance between 2 panels must not exceed 400m. If it is required to exceed this distance then an A-485 which is a RS-485 protocol line amplifier must be used.

In each connection a resistance 120Ω must be placed as figure 3-11 shows

The shield of the cables must be connected to the chassis of the panel.

First of all, all subpanels must be programmed. The automatic setup of the network from the master panel take place after.



Date	9/7/2018
File	BSR-2114/MAR
Document Number	921211401_09_002
Page	27 από 74

3.4.6 Connection panel with repeaters

Up to 4 repeater can be connected to a panel. The below figure shows the connection.

The repeaters can be BSR-2000/MAR or BSR-21XX/MAR (in repeater mode).

First of all, the panel must be programmed to work as repeater, and after that they can be connected with panel. After the wiring the master panel can detect the repeaters from the menu.

Resistances 120Ω must be connected to the terminals of the panel and the last repeaters, as shows at the below figure
The shield of the cables must be connected to the chassis of the panel.

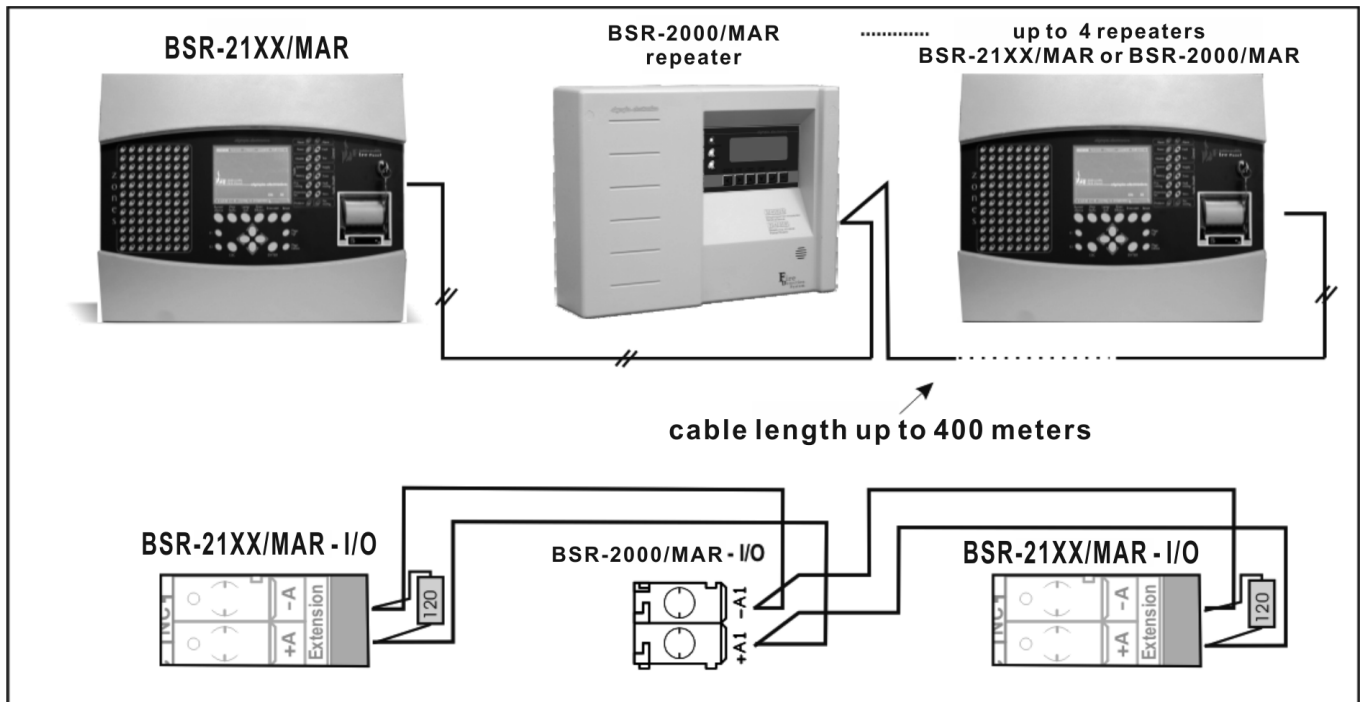

Figure 3-13 Repeater connection

3.4.7 Fire alarm routing and fire protection connections

The panel has provision of Fire Alarm routing and Fire Protection routing (output type A).

The Fire Alarm Routing terminal is the terminal Relay1 +,-.

The Fire Protection routing terminal is the terminal Relay3 +,-.

Both outputs are monitored for open and short circuit fault condition by fitting a 5,6kOhm end of line resistor at the receiving end.

They operate on the voltage-reversing principal so the receiving end equipment must be polarised and suppressed.

A typical connection is shown below

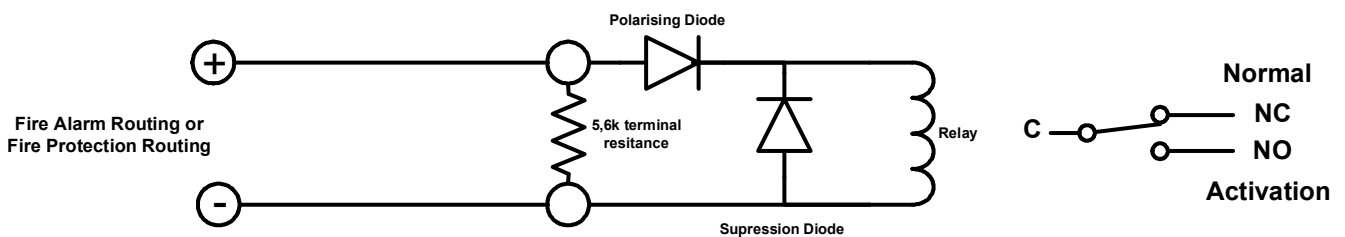

Figure 3-144 Fire Alarm Routing and Fire Protection connection.



These outputs can be used to signal fire alarm equipment such as diallers etc.

These outputs are according to EN 54-2.

These output can be used to operate in differently to default setting, but then they will not fulfil the EN 54-2.

3.4.8 Fault routing connection

The panel has provision of Fault routing.

The Fault Alarm Routing terminal is the terminal Relay2 +, -.

The output is monitored for open and short circuit fault condition.

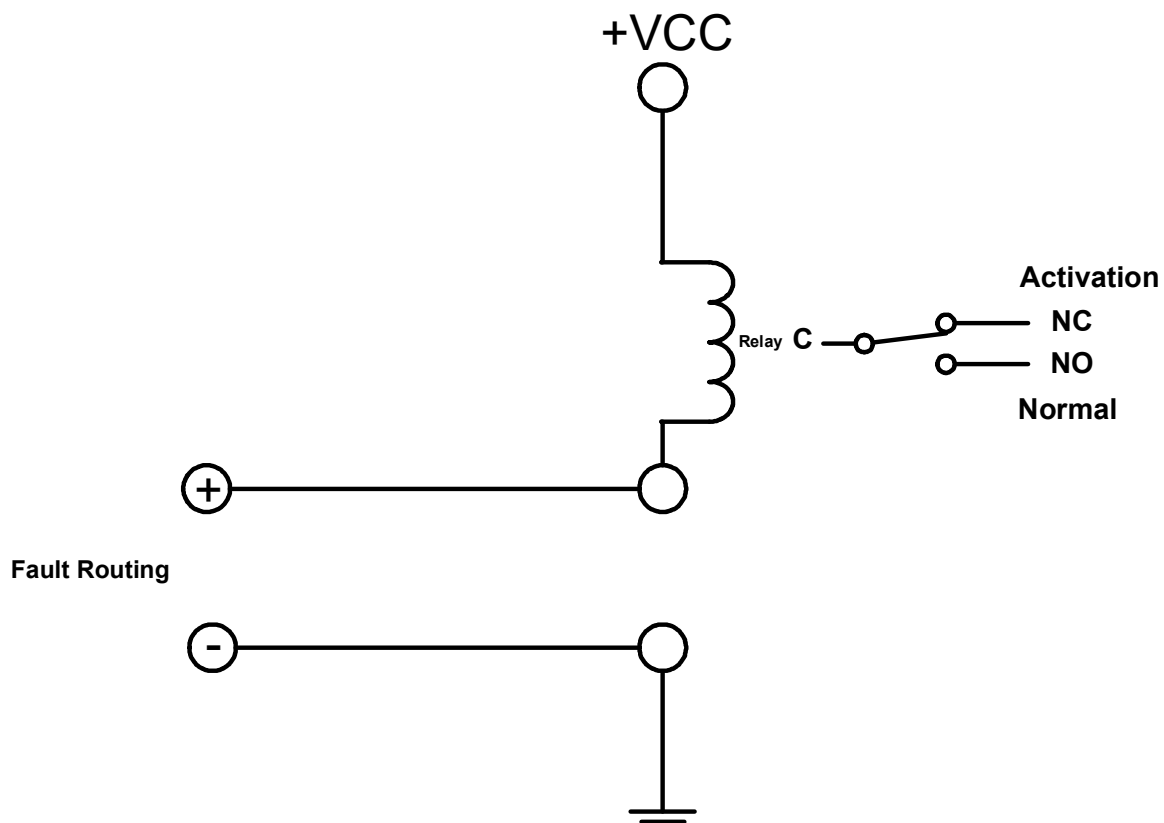

Figure 3-15 Fault warning routing connection.

These outputs are according to EN 54-2.

These output can be used to operate in differently to default setting, but then they will not fulfil the EN 54-2.

3.4.9 Various other connections

The panel also has the following available outputs:

Input/Output board

- **Extension +A , -A terminals** : These outputs are used for connecting external devices to the panel (i.e. external relays, repeaters).
- **V_OUT terminal**. 24V DC output voltage (up to 600mA) can be used to power devices that cannot be powered by the loop (i.e. gas detectors or automatic door release electromagnetic latches).
- **FAULT terminal** . Open collector outputs. When there is a general fault this output is permanently activated (0V) where as when there is a fault of the main processor the output is toggled on and off.
- **ALARM terminals** . Open collector outputs. When there is a general alarm the output is continuously activated (0V). When there is an alarm in the operation of the main processor then the output is toggled ON and OFF.



- **NO,C,NC terminals of the relays 4,5,6.** These are voltage free relay contacts with a rating of 230V/5A. By default they are programmed to operate as alarm relays. This programming can be changed.
- **A1,A2 and A3 terminals.** These are inputs of the panels that can be up to 24V.

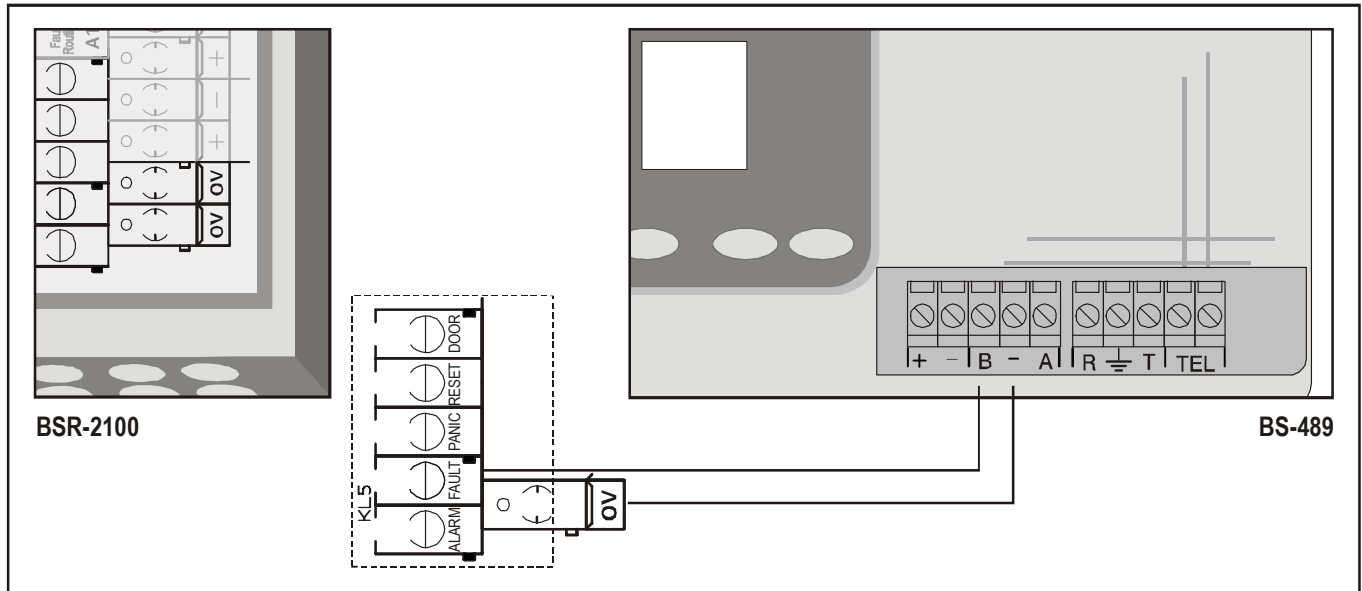

Figure 3-16 Connecting an automatic dialer to the panel.

3.5 Calculating the loop consumption and the required cable cross section

The power for sensors - devices is taken from the BSR-2100 panel which offers a maximum current of 200mA in a quiescent state and 250mA in an alarm state. It is essential to calculate the maximum current requirements of the installation so as not to exceed the above limits.

Table 3-1 Device consumptions

Model	Description	Quiescent consumption	Alarm consumption	Maximum number of connectible devices
BSR-6055/A/MAR	Smoke detector	1	1,2	150
BSR-6057/A/MAR	Smoke detector/Heat detectors	1	1,2	150
BSR-6060/A/MAR	Heat of Rise detector	1	1,2	150
BSR-5036/A/MAR	Call point	1	1,2	150
BSR-7070/A/MAR	Line isolator	2	4	32
BSR-7071/A/MAR	Line isolator	10	10	4
BSR-8017/MAR	Input / Output unit	1	1,5	128
BSR-5032/MAR	Siren	1	6	128
BSR-5032/WP/MAR	Waterproof Siren	1	8	30

The calculation of the total consumption of the installation is done based upon the quiescent current of each device. Also we must take into account the activation current of the units that are located in the same area during the alarm. The calculation can be done using the PC based software program of the (BSR-2100), in the menu "Installation help".

If for any reason the total current must be exceeded then one solution is to install some of the devices on the other loop.

One other essential parameter, that we must take into account for a good installation is the used cable cross section. The cable cross section is important because it is directly linked to the cables resistance. A very big resistance due to small cables cross sections can lead to voltage drops across the line. The table below shows the minimum cable cross section (in regards to distance and current), in order for an installation to operate correctly.



Table 3-2 Loop cable length

Cable Length (m) \ Quiescent Current (mA)	200m	500m	1000m	1500m	2000m
50mA	0.5 mm ²	0.5 mm ²	0.75 mm ²	1 mm ²	2.5 mm ²
100mA	0.5 mm ²	0.5 mm ²	0.75 mm ²	1 mm ²	2.5 mm ²
150mA	0.5 mm ²	0.5 mm ²	1 mm ²	1.5 mm ²	2.5 mm ²
200mA	0.5 mm ²	0.5 mm ²	1,5 mm ²	1.5 mm ²	2.5 mm ²

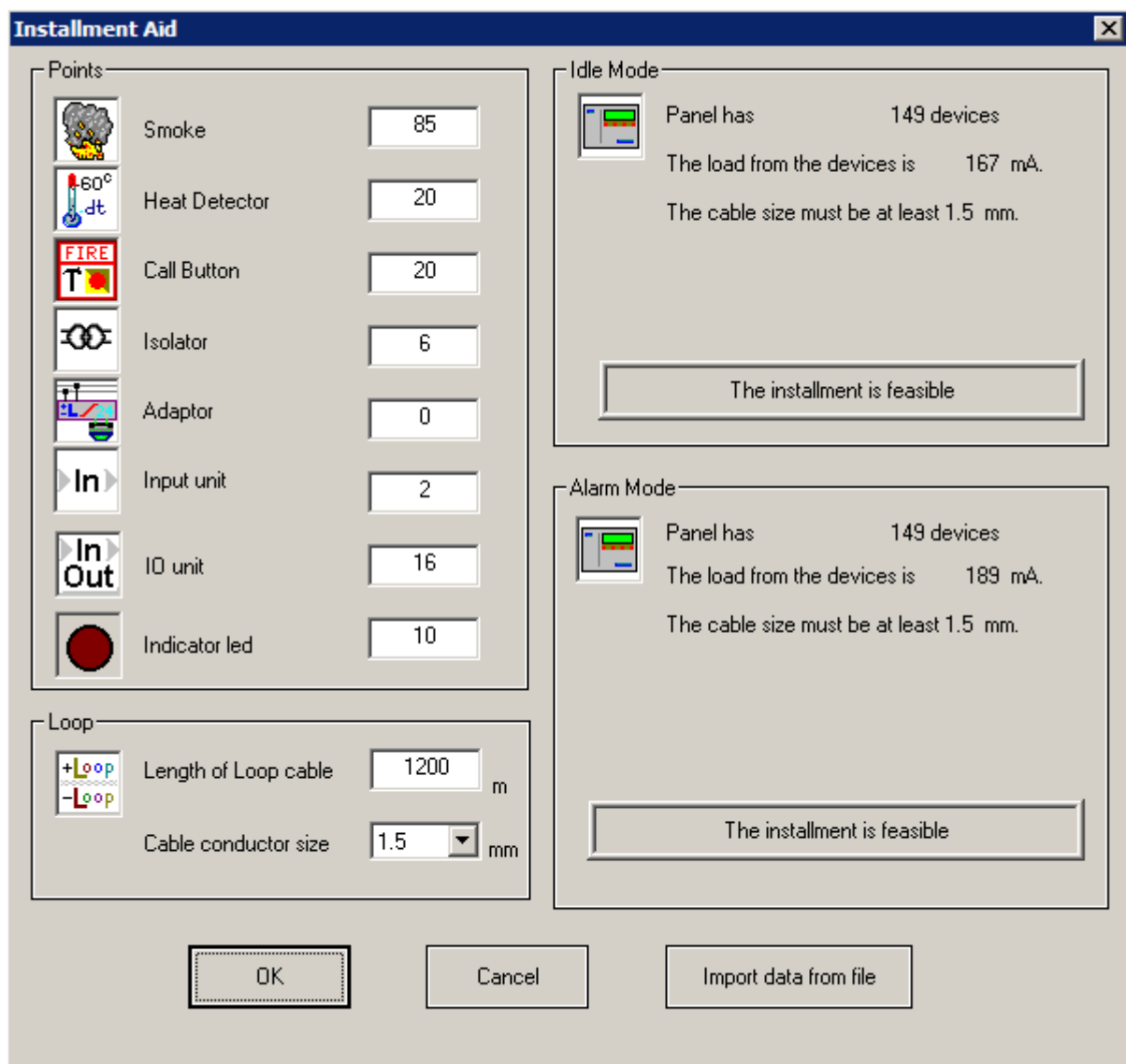

Figure 3-17 Calculating loop consumption with a PC.

In order to fully understand this we will explain it with an example.

In a 70 room hotel we will use a BSR-2100 panel. Each room has a smoke detector and every three rooms there is a manual call point and finally there is a line isolator on every floor. The total cable length of the installation is 1200 meters. Also the system will be divided into 16 zones, thus we must use 16 input/output units.

The consumption of the installation during the normal operation in mA is:

$$I_{\text{quiescent}} = 1 \times N_{\text{smoke detectors}} +$$



Date 9/7/2018

File BSR-2114/MAR

Document Number 921211401_09_002

Page 31 από 74

- 1 x N_{heat of rise detector} +
- 1 x N_{call point} +
- 4 x N_{line isolators} +
- 10 x N_{Conventional devices drivers} +
- 1 x N_{Input units} +
- 1 x N_{input/output units}
- 0 x N_{indication LED}

$$= 1*85 + 1*20 + 1*20 + 4*6 + 10*0 + 1*2 + 1*16 + 0*10 = 167\text{mA}$$

Where «N» is the number of devices i.e. N_{smoke detectors} is the number of smoke detectors in the installation.

In an alarm condition we must also calculate the additional current of the activated devices. Let's presume that 4 detectors, 2 input/output units and 2 indication LEDs are activated then the additional current is:

$$I_{\text{additional current}} = (1,5-1)*4 + (6-1)*2 + 5*2 = 22 \text{ mA}$$

The total current is :

$$I_{\text{Total}} = I_{\text{quiescent}} + I_{\text{Additional current}} = 167\text{mA} + 22\text{mA} = 189\text{mA}$$

Since the installation has a cable length of 1200m and considering the table above we can see that the cable cross section for this current must be 1,5mm.

Be advised that if the installation is done in an industrial area or if the cables pass near frequency generating equipment such a motors, generators, ballasts, e.t.c then a shielded cable must be used.

3.6 Cabling

The panel has cable knock outs that are located on the top and bottom sides of the casing. (see figure 3.4).

Do not remove the grommets in order to not change the protection class (IP30) of the cover. (required by regulations EN 54-2).

Each connection should have it's own cable, for example, for connecting the loop or the siren use a 2 core cable whereas the connection with the main power supply use 3 core cable.

All shielding form the cables and all ground must be connected to the electrical connection terminal block found at the left side of the panel.

The connection cables must be suitable for fire detection installations such as FIP200, MICC, PYROFIL.

The cables that are used for transmitting data must be of the twisted pair type and must have insulation.

The terminal blocks of the panel can accept cables with a cross section of up-to 2,5mm. The terminals should be tightened even if no connection is done with them.

The cable cross section for conventional sirens is shown in the table below.

Table 3-3 Siren cable length (Alarm)

Cable length(m) \ Alarm current (mA)	200m	500m	1000m	1500m	2000m
100mA	1.0 mm ²	1.0 mm ²	2.0 mm ²	2.5 mm ²	2.5 mm ²
250mA	1.0 mm ²	1.5 mm ²	2.5 mm ²	2.5 mm ²	2.5 mm ²
500mA	1.5 mm ²	1.5 mm ²	2.5 mm ²	2.5 mm ²	2.5 mm ²

The central power supply of the panel must be connected to the mains power supply using a fuse with a rating of 16Amp. This fuse should be labeled «Fire Detection System - Do not isolate».

The central power supply must have a ground cable that is connected to the central grounding of the building.

  <p><i>for a safer world!</i></p>	Date	9/7/2018
	File	BSR-2114/MAR
	Document Number	921211401_09_002
	Page	32 από 74

3.7 Mounting

The panel is provided as a package. The package contains the mounting screws and accessories and the instruction manuals.

Remove the panel from the package and locate the lock keys which can be found on the top side of the panel.

Mount the panel in an area that is visible and easily accessible by the personnel that are responsible for the fire safety of the building. The panel is suitable for wall mounting in interior areas. Mounting the panel to the wall uses 3 points in the base of the panel chassis.

3.7.1 Installing a loop to the panel

To properly install a loop to the panel adhere to the following guide lines:

- 1) The maximum number of devices that can be connected to a loop is 150. In this case the connection cable must be at least 1,5mm in diameter.
- 2) Firstly we have to set the address of each device with care. The address setting is done using the micro-switches on each device.
- 3) Make a general installation plan that contains definitions for device information, addresses, cable lengths and cross-section and any other useful information that we help to debug the system in the final stages of commissioning.
- 4) Before connecting the loop cables to the panel check the system for possible errors. These errors could be: short circuits that can be found using a multi-meter, reverse polarity cables and finally cables that are not connected properly or are disconnected.



olympia
electronics
SAFETY & SECURITY SYSTEMS
for a safer world!

Date 9/7/2018

File BSR-2114/MAR

Document Number 921211401_09_002

Page 33 από 74

4 User Menu Section

This section will reference all the function that can be obtained using access levels 1 and 2. To enter the menu, press the «ENTER» key when in the main screen (figure 4-1).

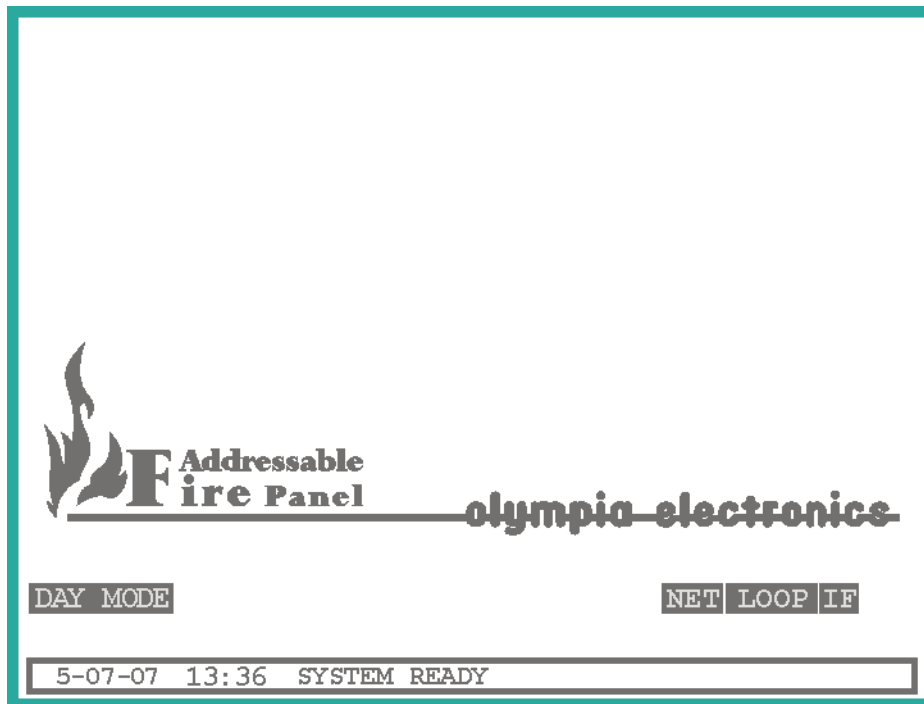

Figure 4-1 Main screen

After that a new option bar is shown at the top of the screen as shown in figure 4-2.

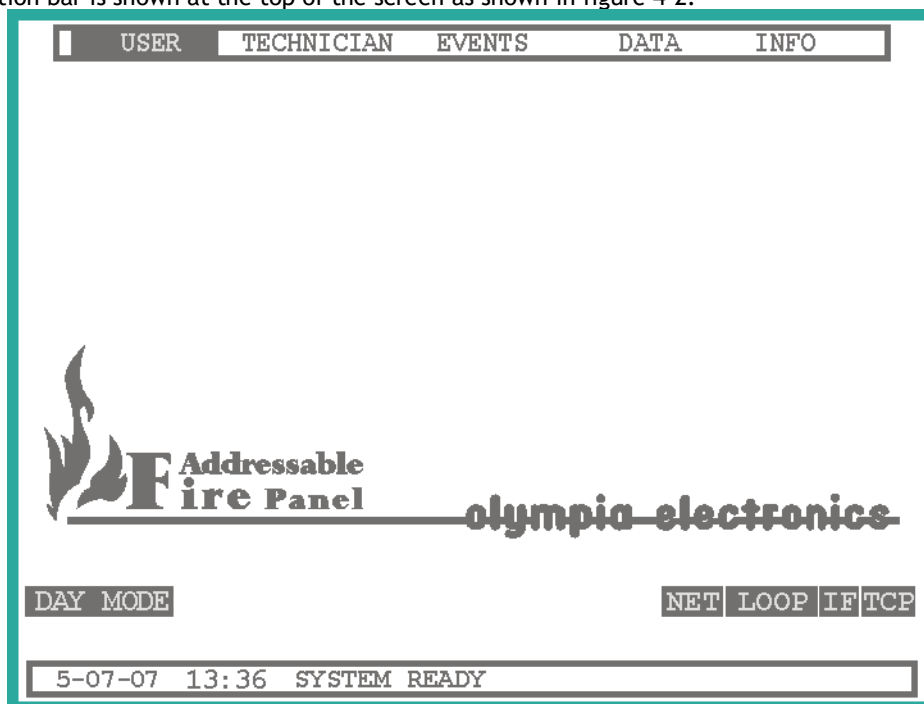

Figure 4-2 Menu



As observed, there are 5 basic menu categories as shown in the diagram of figure 4-4.

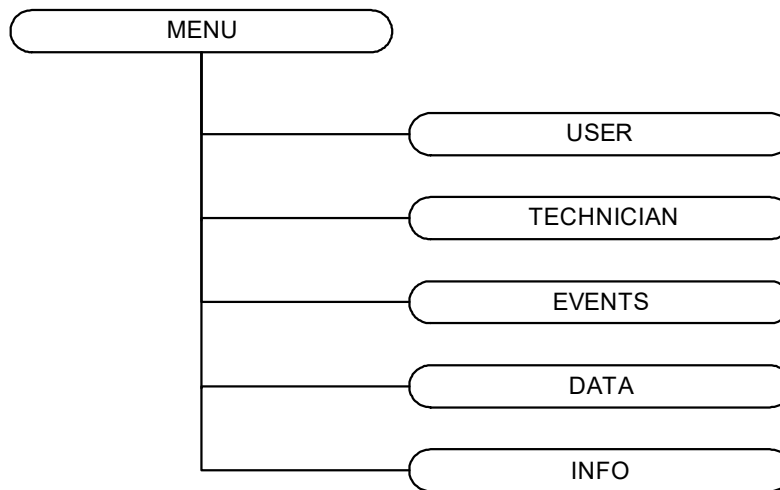

Figure 4-3 Menu diagram

In detail the menu contains:

- **USER** : This menu contains all options that are available to the user that has access to access level 2.
- **TECHNICIAN** : Only the technician has access to this level where panel programming can be done.
- **EVENTS** : In this menu we can see all the events of the panel.
- **DATA** : Contains functions used for receiving and sending data to a PC.
- **INFO** : This menu contains information about the system that can be accessible by any user.

To select a menu, navigate to the menu using the keys «LEFT» and «RIGHT» and press the «ENTER» key. We will continue in detail of all the submenus except the Technical menu which will be covered in the next section.

4.1 Access Codes

No code is needed in order to access the function in level '1'.

A code is needed to access the functions in level 2. The use of an access code was though essential because in this level there are many functions that are used to control the panel during an alarm or fault condition.

The code for access level 2 is

<p style="text-align: center;">ACCESS CODE FOR LEVEL '2' ACCESS LEVEL 2 1111</p>

4.2 User Menu

If we select the user menu and press «ENTER» then a requester screen will be shown for code entry. Input the code for access level '2'.

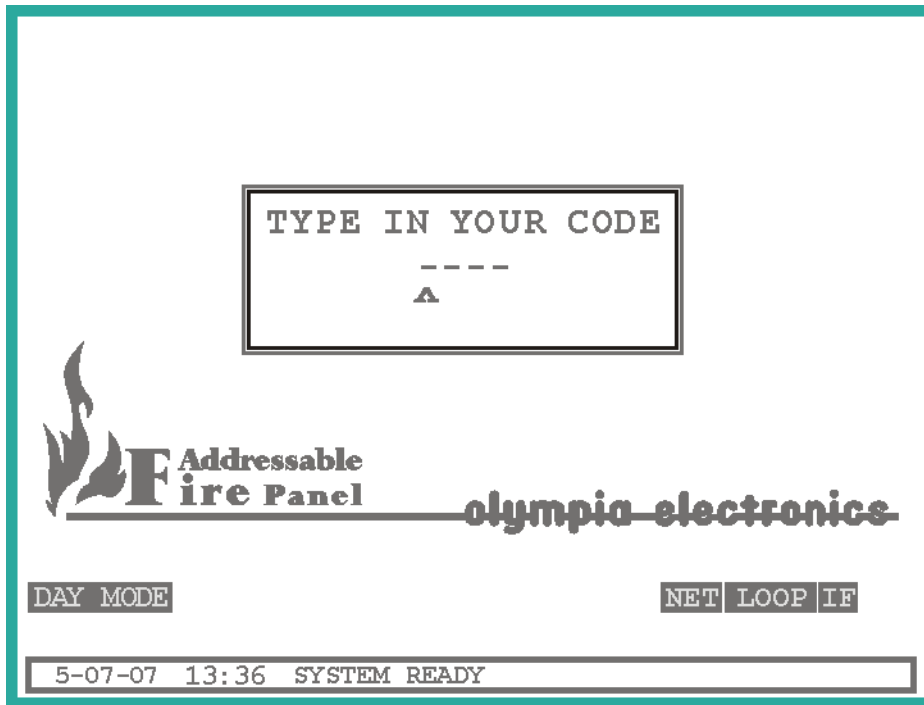

Figure 4-4 User Code

After entering the correct code press the «ENTER» and the submenu will be shown as the figure below.

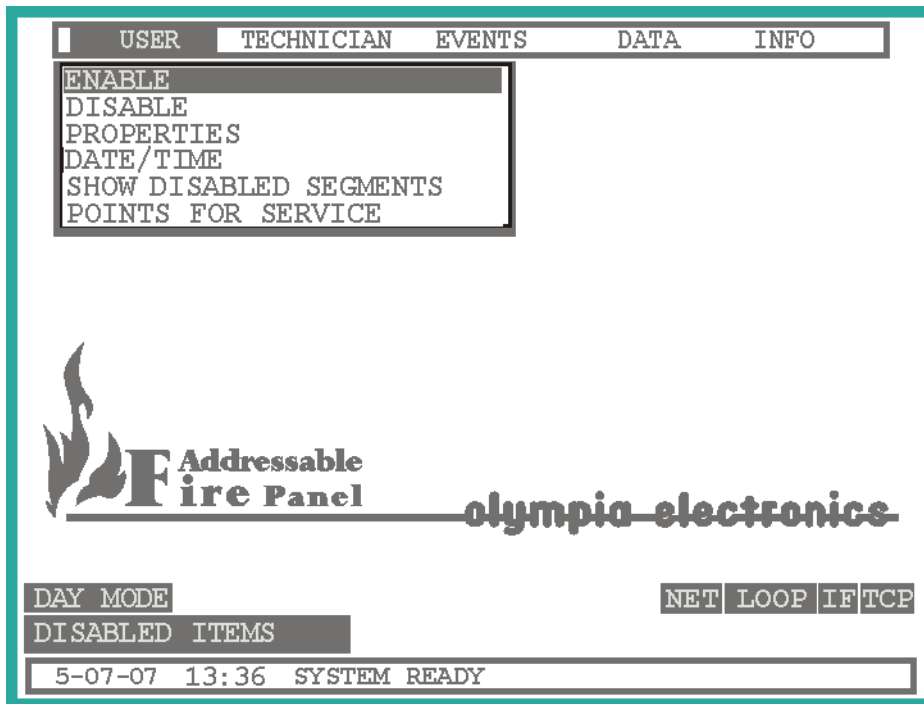

Figure 4-5 User Menu

As shown in the diagram. The user can choose from numerous selections. Figure 4-4 shows the tree-diagram of this menu.

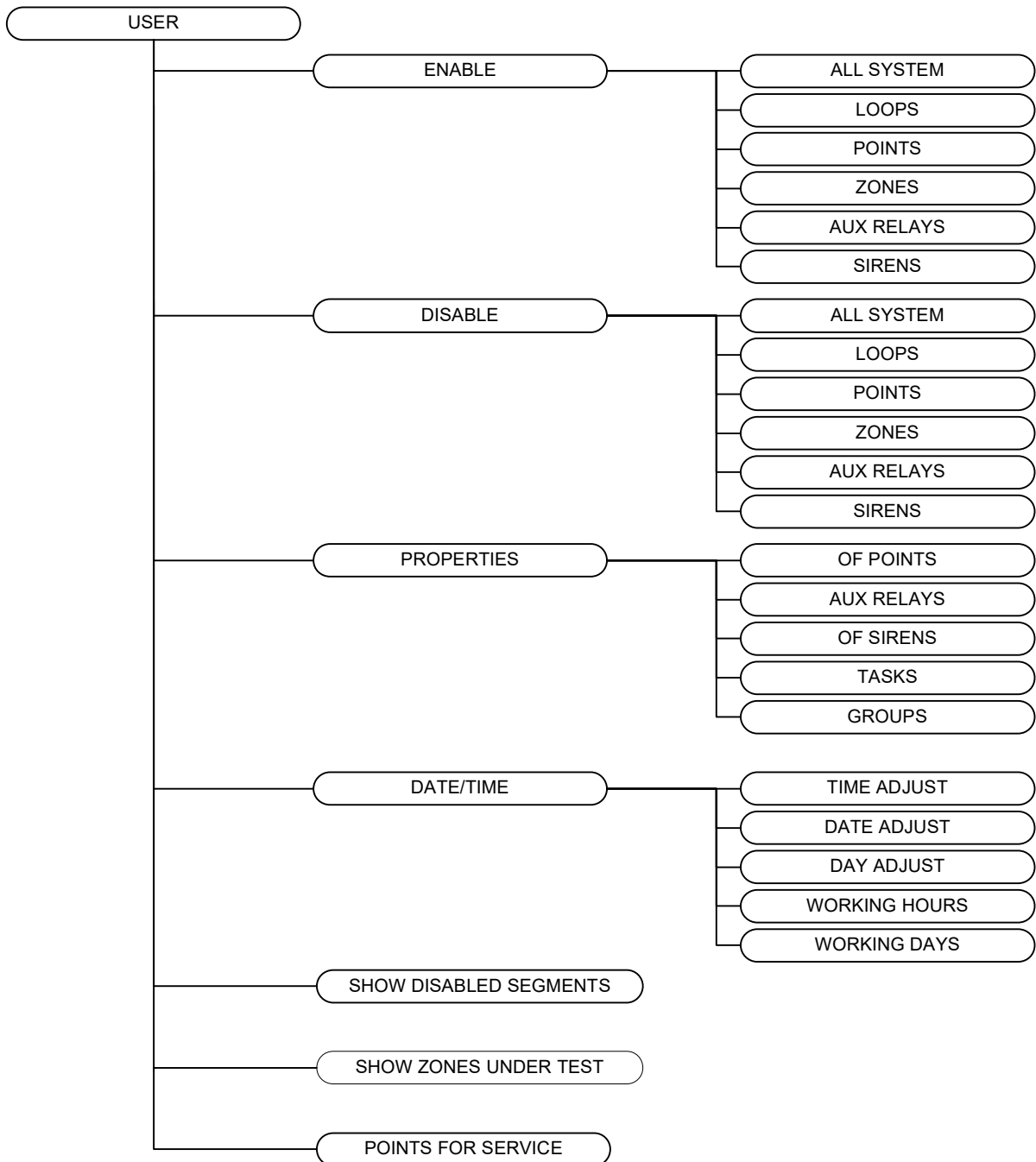



Figure 4-6 User menu diagram

  <p>SAFETY & SECURITY SYSTEMS</p> <p><i>for a safer world!</i></p>	Date	9/7/2018
	File	BSR-2114/MAR
	Document Number	921211401_09_002
	Page	37 από 74

4.2.1 Enable - Disable menu

With the Enable option we can enable any element of the panel as shown in figure 4-7.

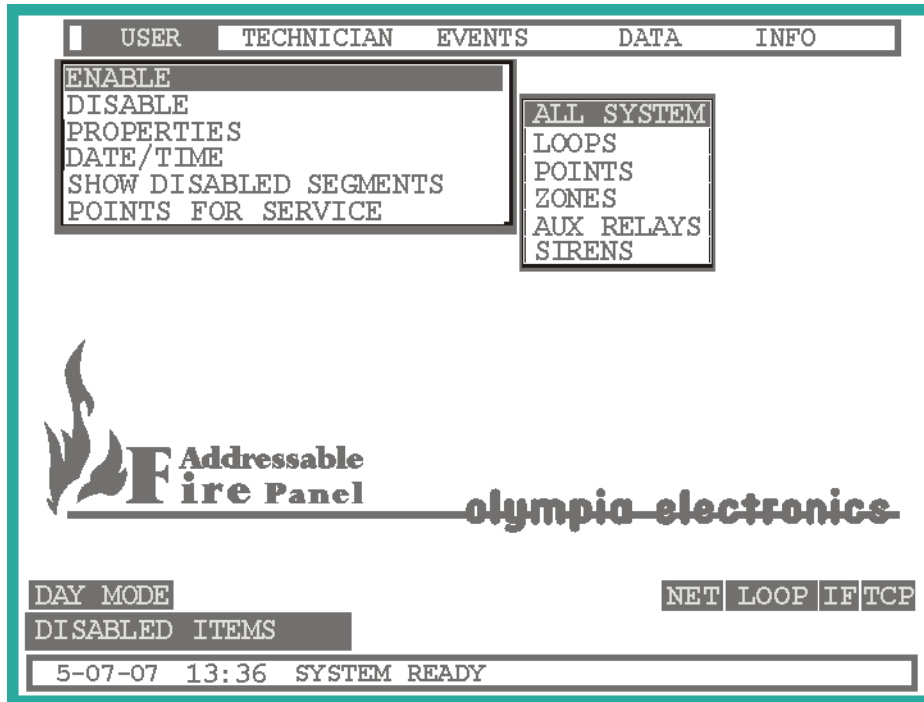

Figure 4-7 Activation Menu

We have the following selections :

- **ALL SYSTEM** : All the elements of the panel are enabled
- **LOOPS** : Select from 1 to 8 which loops you want to enable.
- **POINTS** : Select the loop and then the point that you want to enable.
- **ZONES** : Select which zone you want to enable (1 - 96). If ALL is selected then all zones are enabled.
- **AUX RELAY** : Select which of the 6 relays do you want to enable.
- **SIRENS** : Select 1 of the 8 sirens that you want to enable.

Respectively in the disable menu we have the same selections as the enable menu but now we can use them to disable elements.

4.2.2 Properties menu

With the use of this menu, the user can read the settings of every element in the panel. This menu has the following functions:

- **OF POINTS** : See the setting of a point.
- **AUX RELAYS**: See the setting of each relay.
- **OF SIRENS** : See the settings of each siren.
- **TASKS** : See the settings of each function.
- **GROUPS** : See the settings of each group.

In the properties menu we cannot make any changes to the panel. It is used only for viewing information.

If we select the POINTS option then a window similar to the one shown in figure 4-8 will be shown.



Date	9/7/2018
File	BSR-2114/MAR
Document Number	921211401_09_002
Page	38 από 74

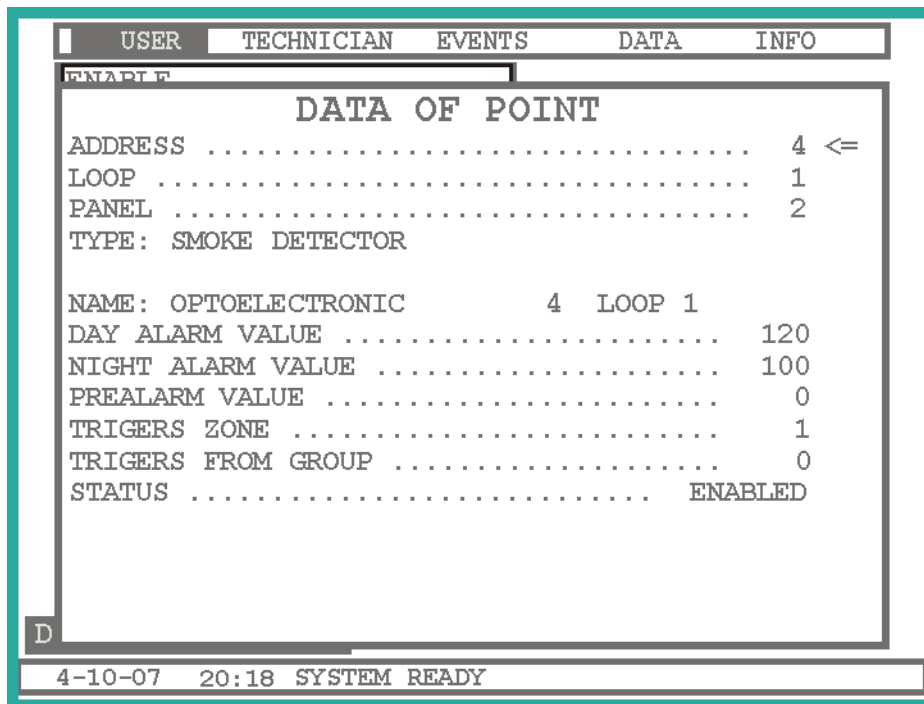

Figure 4-8 Point properties

Depending on the type of point, different settings will be shown.

We can change the loop and the address with the «LEFT» and «RIGHT» keys. After the setting has been adjusted then by pressing «ENTER» we can make the change.

The windows also shows the following fields :

- **TYPE** : Describes the type of point. If a point is not installed then the field shows “-----”.
- **NAME** : The name of the field up-to 32v characters.
- **DAY ALARM VALUE** : The limit set that the device will give an alarm during the day. If the limit is exceeded during the day time hours then the device will give an alarm.
- **NIGHT ALARM VALUE** : The limit set that the device will give an alarm during the night. If the limit is exceeded during the night time hours then the device will give an alarm.
- **PRE-ALARM VALUE** : The value of the pre-alarm of the device. Over this value the device will issue a pre-alarm.
- **ACTIVATES THE ZONE** : When a sensor is activated then the respective zone is also activated.
- **ACTIVATES THE GROUP** : When a sensor is activated then the respective group is also activated.
- **STATUS** : The status of the point (If it is activated or deactivated).

The meaning of «day» - «night» is covered in paragraph 4.2.3

In the same way we can see the settings of the Relays and the Sirens.

If we select the setting «TASKS» we can view the settings of the tasks. The «TASKS» option is a procedure that consists of multiple events, i.e The fire extinguishing system will operate when 2 or more zones are activated. These events can be activated as one function.

After selecting the function, a small window opens that prompts the user to input the functions number 97-150.

As shown in the figure below, function 97 is activated if zones 2, or 19 or 25 are activated.

Function 97 can be used to activate a relay on the panel, or a siren or one output on the loop.

In general the task setting is a good tool that can be used by the technician in order to automate certain tasks.

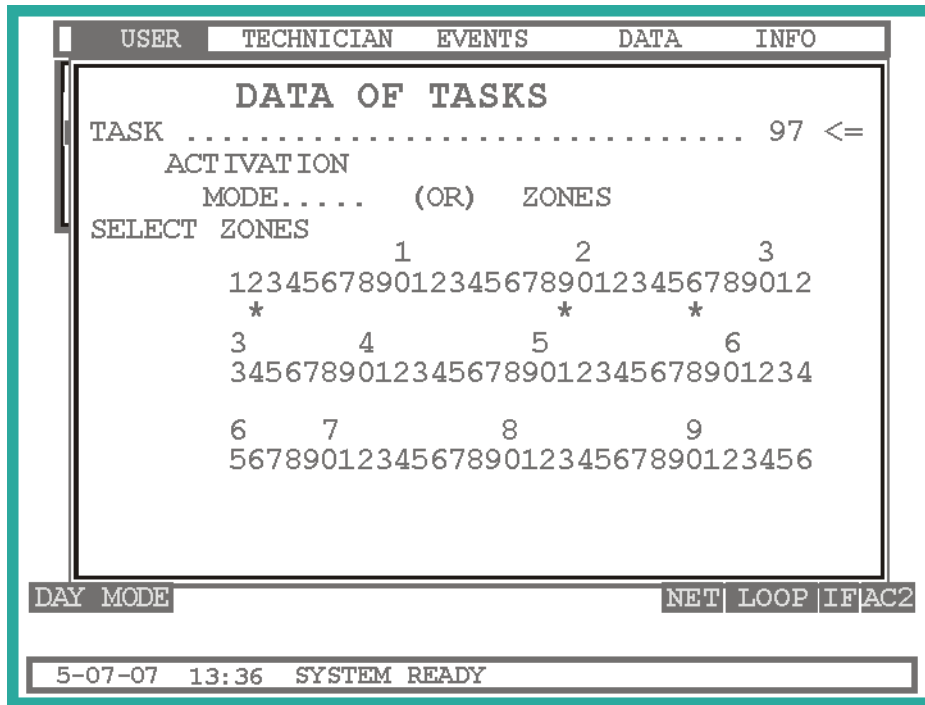

Figure 4-9 Functions

If we select the «GROUP» option then we can see it's settings. Specifically, each group consists of many zones, and when one is activated then all the others are activate too. When we select "Groups" then a small window opens prompting the user to enter the number of the groups from 1 to 96. After that a new window opens as shown below.

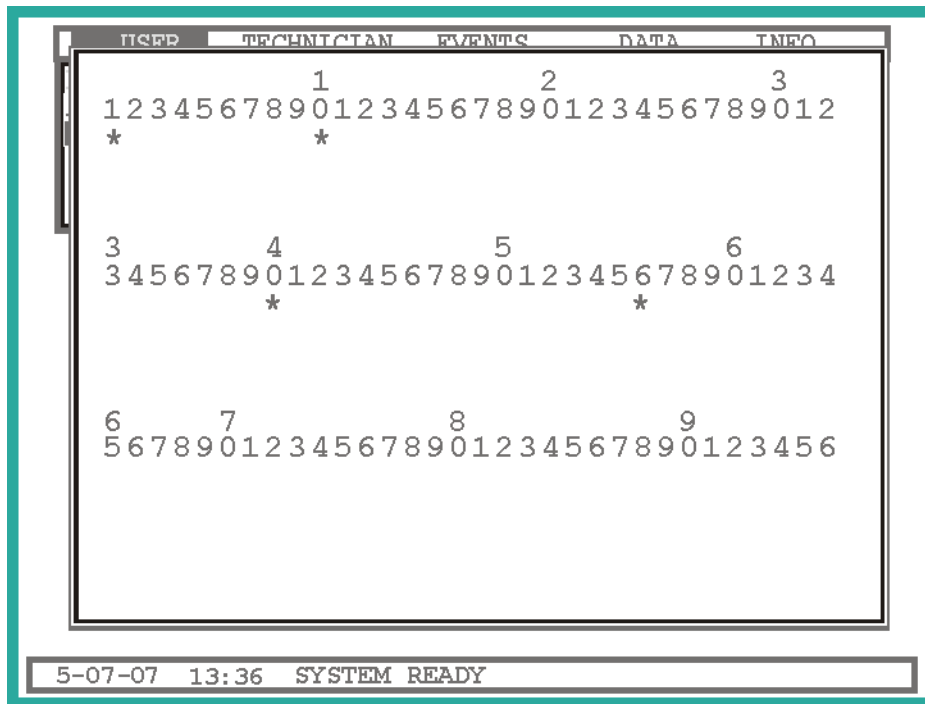

Figure 4-10 Group

This figure shows the zones that the group consists of. When a zone has an asterix under it then it belongs to that group. In our example zones 1,10,40 and 56 belong to the group.

4.2.3 Date - Time menu

The user has the following options in this menu :

- **TIME ADJUST** : Adjust the time of the system.
- **DATE ADJUST** : Adjust the date of the system.
- **DAY ADJUST** : Adjust the day of the week of the system.
- **WORKING HOURS** : Adjust the working hours for the option «DAY» or «NIGHT».
- **WORKING DAYS** : Adjust the working days for the option «DAY» or «NIGHT».

In the first three selections we adjust the time, date and day of the system. To make changes use the directional keys and to confirm the setting press the key «ENTER».

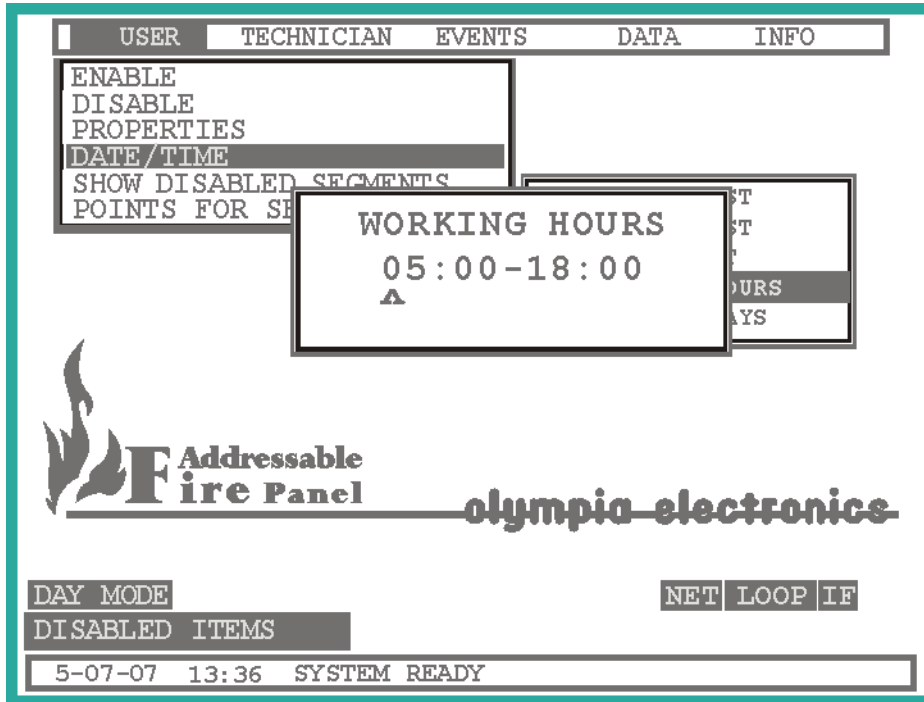

Figure 4-11 Working hours menu

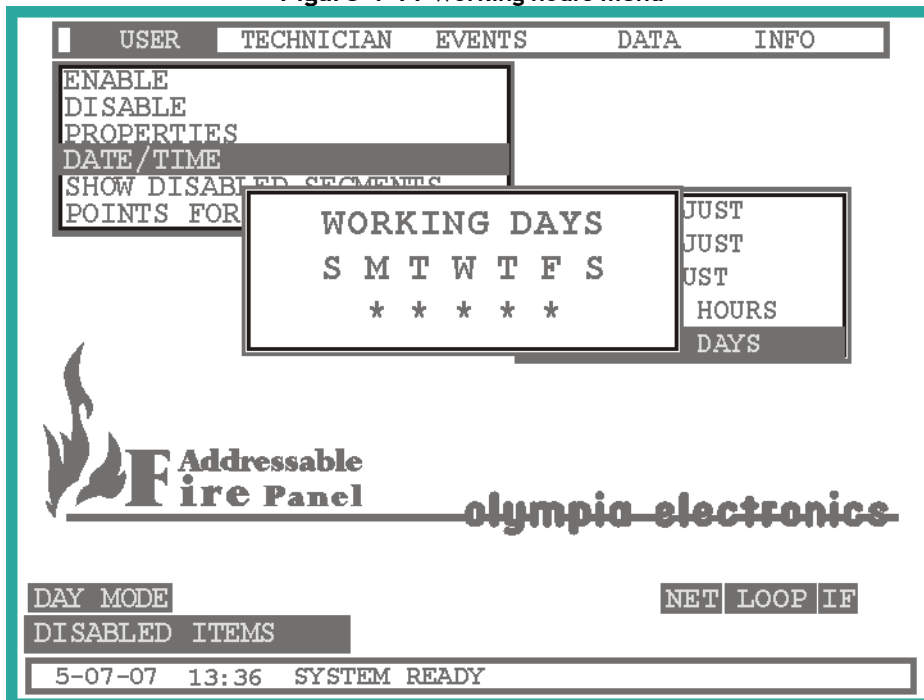

Figure 4-12 Working days menu

The definition of the time of «DAY» is determined by the above 2 screens. With these two screens we can set when employees are in the building.

In most buildings during the day time and due to presence of employees, it is not always required that the fire detection system operate with big sensitivity. This is because the employees can cause false alarms. In the other case, at night it is essential that the system operates with a greater sensitivity because there is not enough supervision. For this reason the meaning «DAY» or «NIGHTS» were developed. To sum it up, during the day the detectors are less sensitive and during the night the sensitivity increases.

4.2.4 Show Disabled Segments menu

Using this menu we can see which items are disabled as shown in the figure below.

<div style="display: flex; justify-content: space-between;"> USER TECHNICIAN EVENTS DATA INFO </div>					
DISABLED SEGMENTS					
					< 5 >
NO.	NAME				
1	LOOP	4			
2	ZONE	94			
3	SIREN	2			
4	AUX RELAY	2	PANEL	2	
5	ROOM	450			
PANEL	LOOP	ZONE	POINT	VALUE	DATE TIME
2	4	-	-	-	- -
SOURCE		LOOP 4			
5-07-07 13:36 SYSTEM READY					

Figure 4-13 Disabled sections

Beside the title we can see the total number of disabled items. The top section is divided into two areas. The general number of the item and the name of the item. The bottom section shows all the details of the item that we have chosen. (black bounds). In our example, the system is informing us that loop 4 on panel 2 is disabled.

To navigate to other items use the «UP» or «DOWN» keys or for faster scrolling use the «PAGE UP» or «PAGE DOWN» keys.

If there are no disabled items then the following message will appear «THERE ARE NO DISABLED SEGMENTS».

4.2.5 Show zones under test

Using this menu we can see how many zones are under test and which.

4.2.6 Point for service menu

There are some types of detectors that require maintenance, e.g. smoke detectors. The system has the capability to determine which detectors need maintenance due to dust accumulation. Using this option we can see the list of detectors that need maintenance. (figure 4-14)

USER TECHNICIAN EVENTS DATA INFO					
POINTS FOR SERVICE					< 3 >
NO.	NAME				
1	OPTOELECTRONICS 1 LOOP 1				
2	ROOM 110				
3	STAIRS FLOOR 3				
PANEL	LOOP	ZONE	POINT	VALUE	DATE TIME
0	1	1	1	60	
SOURCE	DETECTOR				
5-07-07 13:36 SYSTEM READY					

Figure 4-14 Sensor due for maintenance



Beside the title we can see the total number of detectors that are due for maintenance.

The top section is divided into two areas. The left area is the general number of the detector whereas the right area contains the name of the detector. The bottom section shows all the details of the item that we have chosen. (black bounds).

In our example, the panel is informing us that the detector with the name «OPTOELECTRONIC 1 LOOP 1» of loop 1, at address 1 that belong to zone 1 needs maintenance.

To navigate to other items use the «UP» or «DOWN» keys or for faster scrolling use the «PAGE UP» or «PAGE DOWN» keys.

If there are no sensors for maintenance then the following message is displayed «THERE ARE NO POINTS FOR SERVICE».

  <p>for a safer world!</p>	Date	9/7/2018
	File	BSR-2114/MAR
	Document Number	921211401_09_002
	Page	43 από 74

4.3 Event menu

Access level1 also permits the user to view current and logged events that are categorized. While in the main screen press the «ENTER» key.

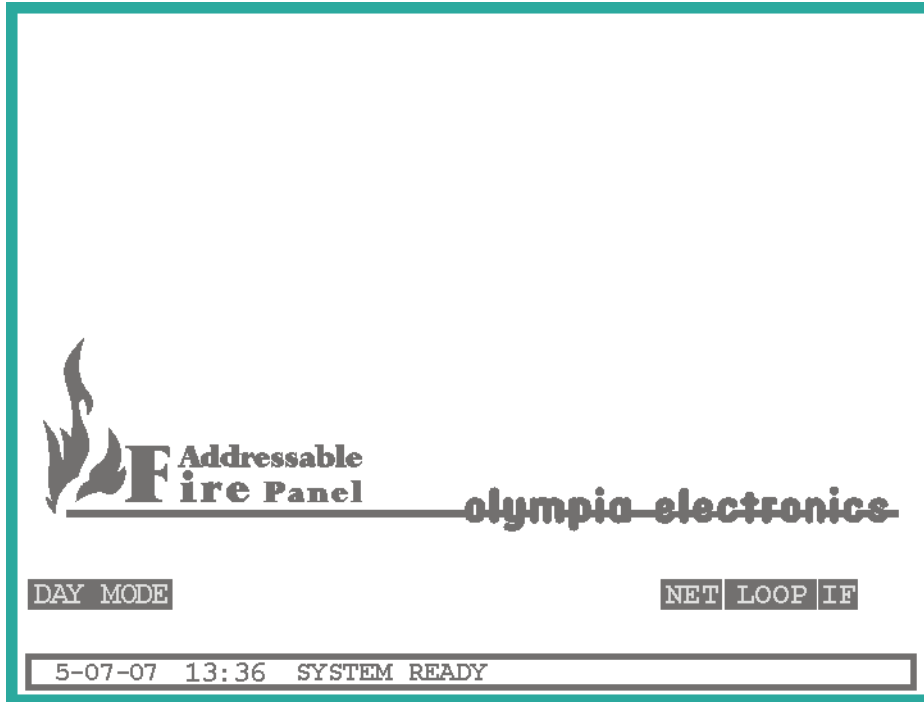

Figure 4-15. Main screen in quiescent state

Next press twice the right key and select the EVENT menu as shown in figure 4-16.

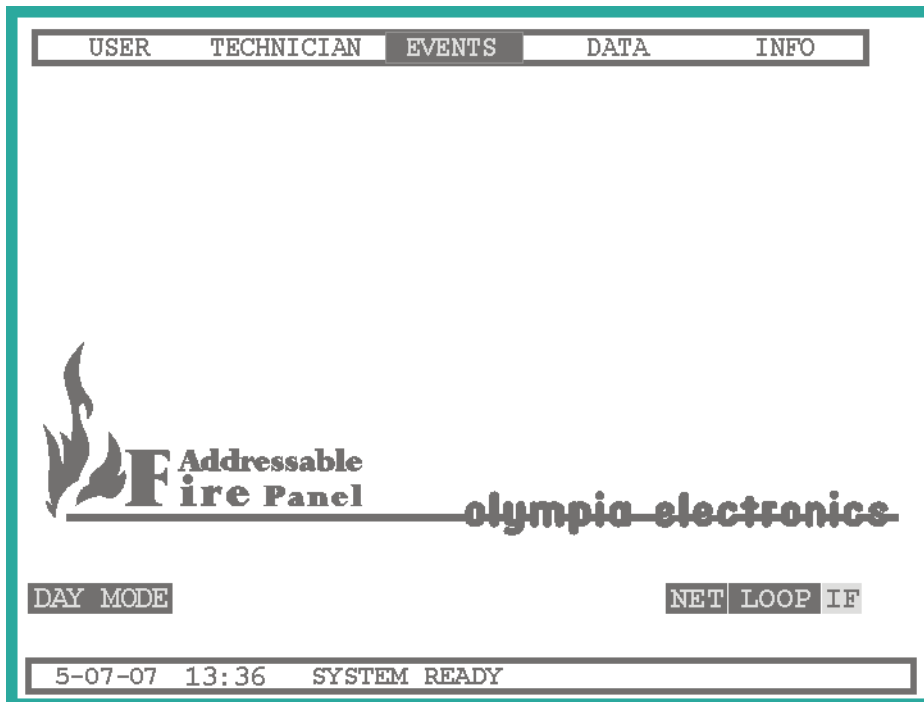

Figure 4-16 Menu

And press again the «ENTER» key.

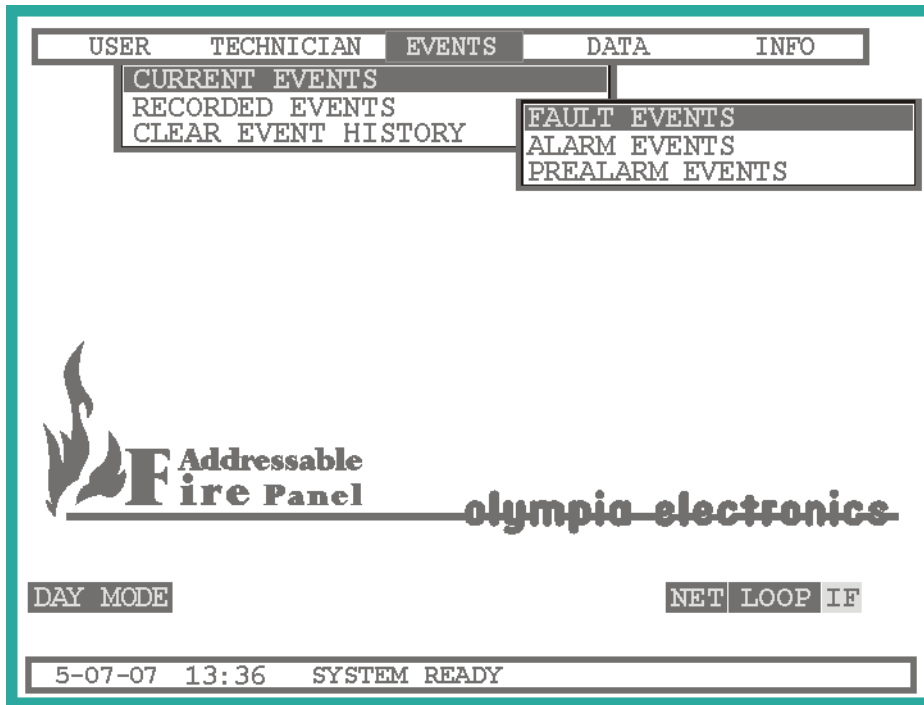

Figure 4-17 Event menu

This way we enter the menu where we can see current and logged menu events.

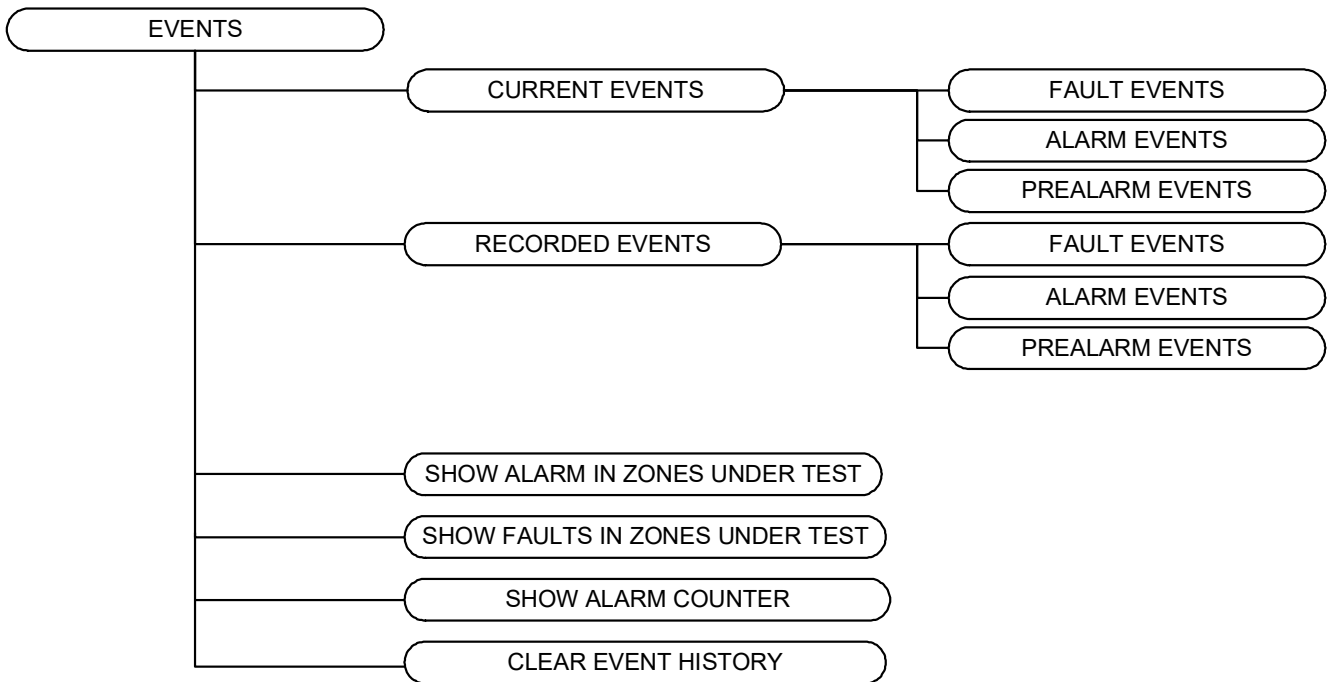

Figure 4-18 Events menu diagram

The options that are available are:

CURRENT EVENTS FAULT EVENTS	With this selection we can see all the fault events of the system. Using the UP and DOWN keys we can navigate through the events. Pressing the ESC key exits this menu and goes to the previous.
--	--



for a safer world

Date	9/7/2018
File	BSR-2114/MAR
Document Number	921211401_09_002
Page	45 από 74

CURRENT EVENTS ALARM EVENTS	If we press the ENTER key we can see all current alarm events if available. Using the UP and DOWN keys we can navigate through the events. Pressing the ESC key exits this menu and goes to the previous.
CURRENT EVENTS PREALARM EVENTS	If we press the ENTER key we can see all current pre-alarm events if available. Using the UP and DOWN keys we can navigate through the events. Pressing the ESC key exits this menu and goes to the previous.
RECORDED EVENTS FAULT EVENTS	If we press the ENTER key we can see all stored fault events if available. Using the UP and DOWN keys we can navigate through the events. Pressing the ESC key exits this menu and goes to the previous.
RECORDED EVENTS ALARM EVENTS	If we press the ENTER key we can see all stored alarm events if available. Using the UP and DOWN keys we can navigate through the events Pressing the ESC key exits this menu and goes to the previous.
RECORDED EVENTS PREALARM EVENTS	If we press the ENTER key we can see all stored pre-alarm events if available. Using the UP and DOWN keys we can navigate through the events Pressing the ESC key exits this menu and goes to the previous.
SHOW ALARMS IN ZONES UNDER TEST	If we press the ENTER key we can see all alarms events in test zones if available. Using the UP and DOWN keys we can navigate through the events. Pressing the ESC key exits this menu and goes to the previous.
SHOW ALARMS IN ZONES UNDER TEST	If we press the ENTER key we can see all faults events in test zones if available. Using the UP and DOWN keys we can navigate through the events. Pressing the ESC key exits this menu and goes to the previous.
SHOW ALARM COUNTER	If we press the ENTER key we can see the numer of alarm counter. Pressing the ESC key exits this menu and goes to the previous.
CLEAR EVENT HISTORY	<p>This selection deletes the history buffer of current and stored events. This option is available to only specialized personnel. When the ENTER key is pressed then a code entry requester pops up. Here we have to enter the code for access level 3.</p> <div style="border: 1px solid black; padding: 10px; text-align: center; margin: 10px auto; width: fit-content;"> <p>ENTER CODE</p> <p>----</p> </div> <p>After this procedure the file is deleted and a system reset is conducted.</p> <p>NOTE: This action should be made only by a technician.</p>

After selecting to view a type of event, a screen that is identical to the one below will appear.



USER		TECHNICIAN		EVENTS	DATA	INFO
CURRENT FAULTS						< 123 >
NO.	SOURCE	DESCRIPTION				
11	DETECTOR	DISCONNECTED UNIT				
12	DETECTOR	OPEN CIRCUIT				
13	AUX 4	OPEN CIRCUIT				
14	SIREN	SHORTCUT				
15	AUX 6	OPEN CIRCUIT				
16	DETECTOR	WRONG TYPE				
17	SIREN 5	OPEN CIRCUIT				
18	PANEL	MAINS FAILURE				
PANEL	LOOP	ZONE	POINT	VALUE	DATE	TIME
2	7	78	72	31	04/07/07	13:20
NAME	ROOM 472 BEDROOM					
5-07-07 13:36 SYSTEM READY						

Figure 4-19 Viewing events

Beside the title we can see the total amount of event of the type selected.

The top section is divided into 3 sections, the general number of the event, the origin of the event and finally the description of the event. The lower section shows details of the event that we have selected to view (black bounds).

In our example the panel informs us that the sensor of panel 2, loop 7, zone 78 with address 72 is not connected. Additionally the name of the detector is displayed «ROOM 472 BEDROOM»

To navigate to other items use the «UP» or «DOWN» keys or for faster scrolling use the «PAGE UP» or «PAGE DOWN» keys.

Up to 500 events of each type can be logged.



4.4 Data menu

With the use of this menu we can make data transfer between the panel and a PC. Before making a transfer, be sure to connect the panel with the PC via the USB port. After that the port setting must be adjusted on the PC.

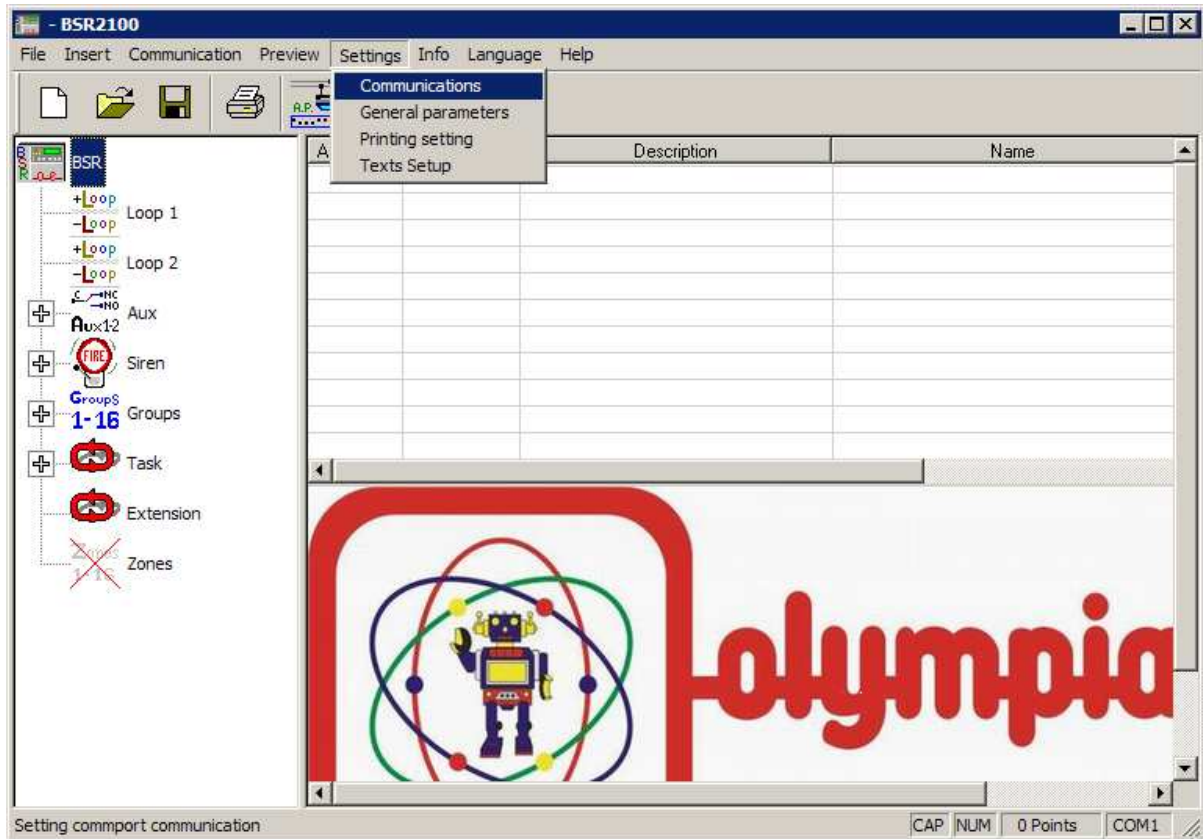

Figure 4-20 Computer software

Select the tab «Settings» and «Port settings» (figure 4-20). Then select the port that the panel is connected too. (figure 4-21).

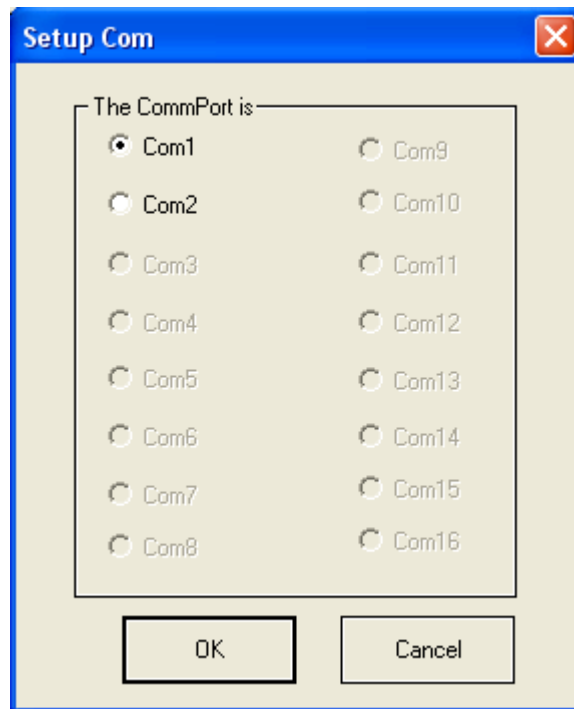

Figure 4-21 Port settings

Select via the «Communication» menu the option to “send” or to “receive” data to the PC. Then select the «DATA» menu of the panel. A code requester will pop up requesting the user to input a code. Input the code for access level 2. After the code has been entered a submenu will appear as shown below.

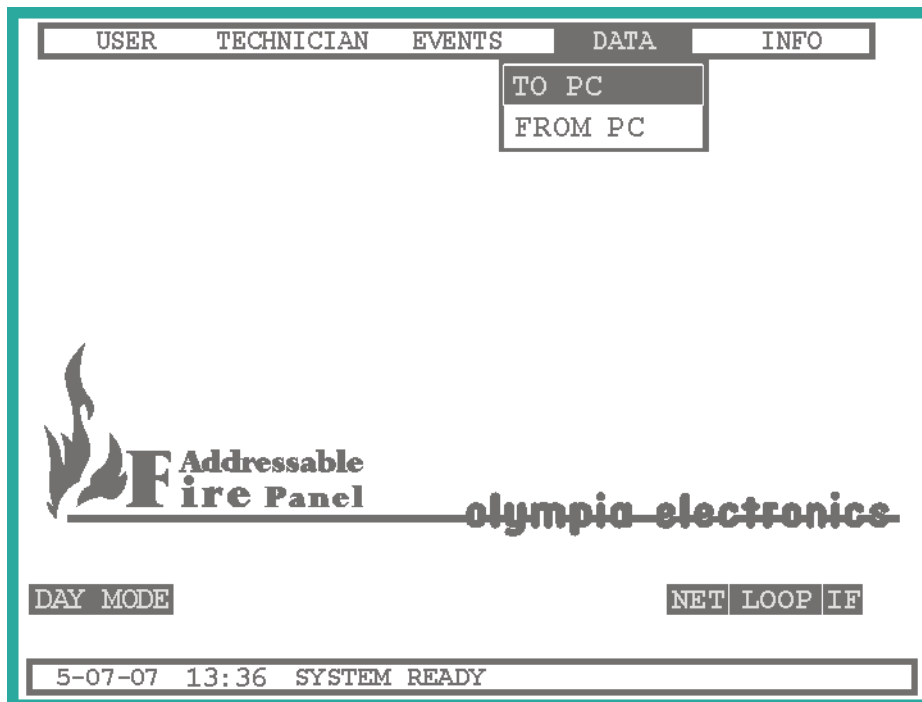

Figure 4-22 Data menu

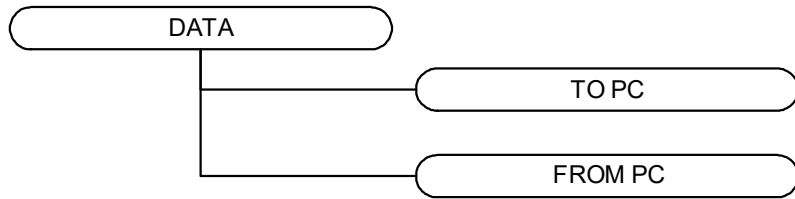

Figure 4-23 Data menu diagram

The selection «TO PC» is used to transfer data to the PC. The selection «FROM PC» is used to program the panel from the PC.

4.4.1 Sending data to the PC

When selecting the option «TO PC» a window is opened that shows a communication test between the PC and the panel.

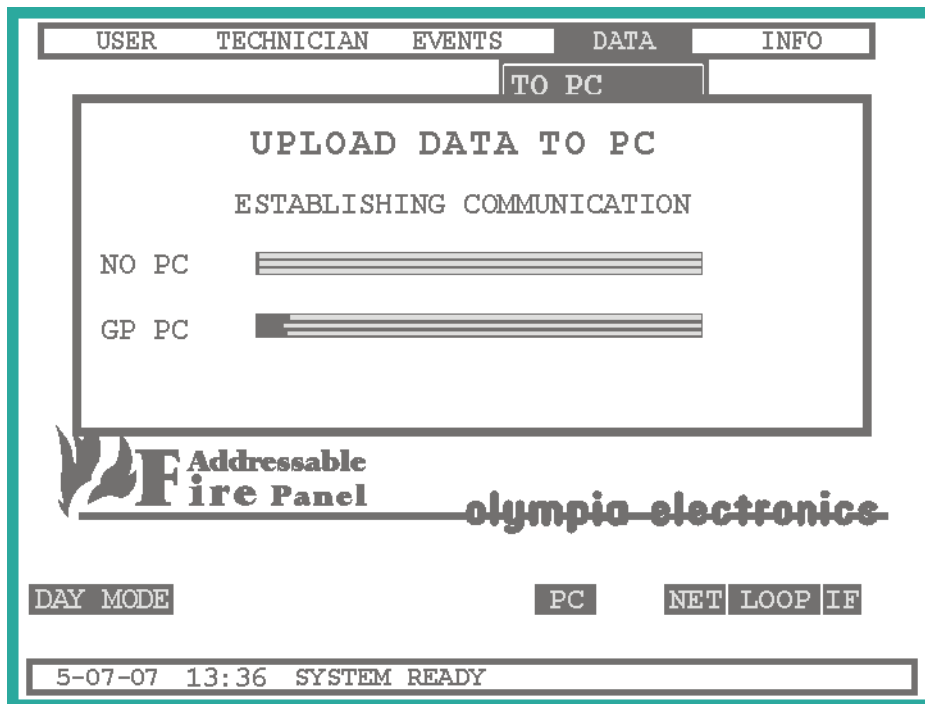

Figure 4-24 Establishing communications

As soon as communications are established between the PC and the panel the data will be transferred to the PC from the panel (figure 4-25). The data that will be transferred will contain all the settings of the panel and all the events.



**olympia
electronics**
SAFETY & SECURITY SYSTEMS

for a safer world!

Date 9/7/2018

File BSR-2114/MAR

Document Number 921211401_09_002

Page 50 από 74

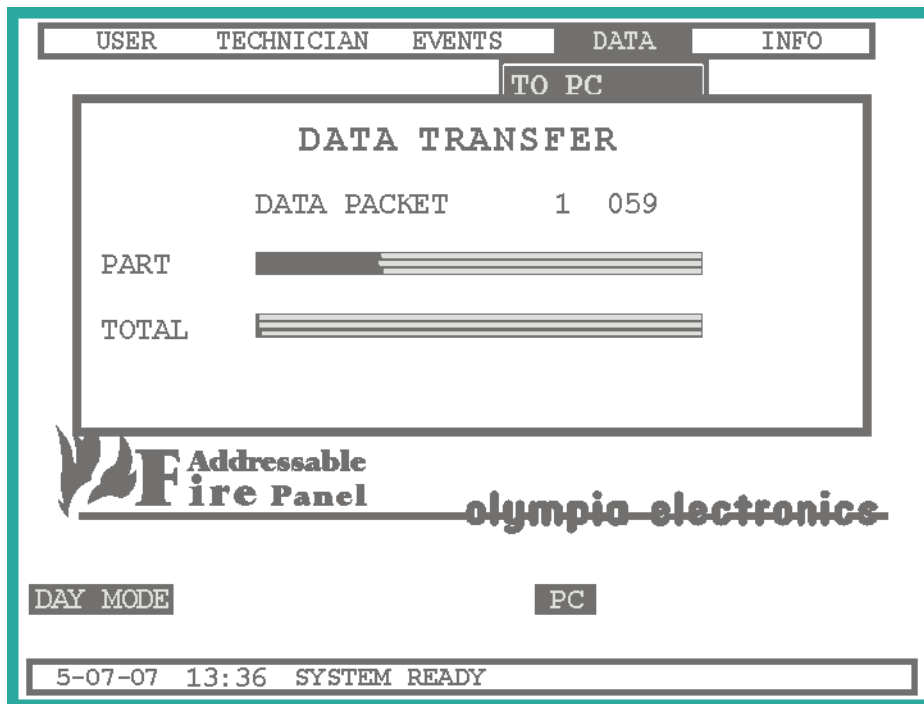

Figure 4-25 Sending data to a PC

When the transfer has finished, press any key to close the window.

4.4.2 Receiving data from a PC

When selecting the option «FROM PC» you must enter the technician code and after a window is opened that shows a communication test between the PC and the panel. (figure 4-26).

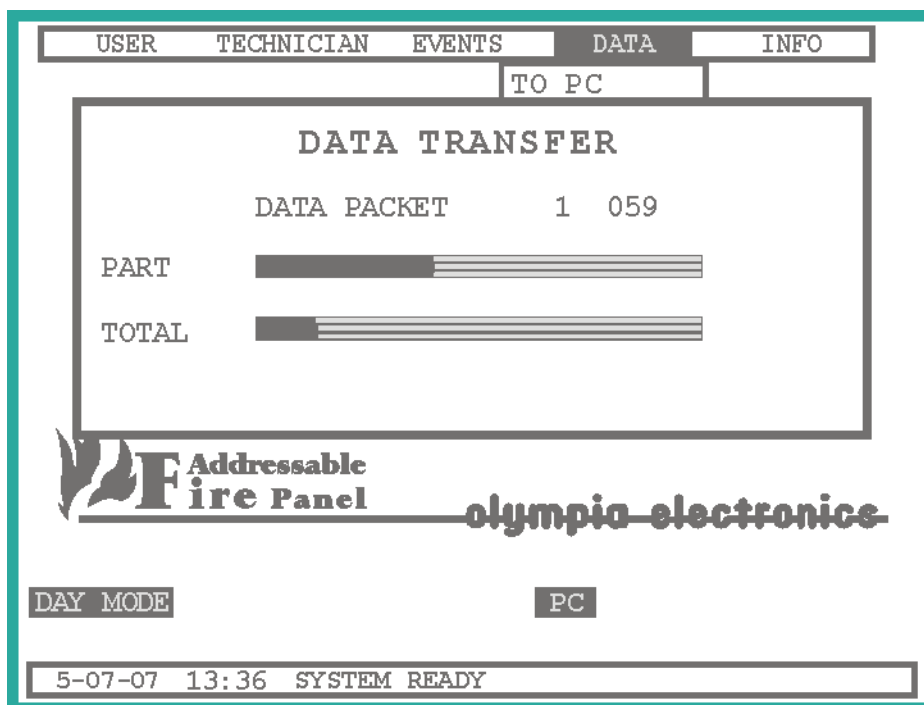

Figure 4-26 Data transfer

After the data is transferred to the panel, the panel conducts a system reset.

4.5 Information menu

Access level 1 permit us to view information about the system. While in the main screen press «ENTER» and then select «INFO» and press «ENTER» again. The information menu will be shown (figure 4-22).

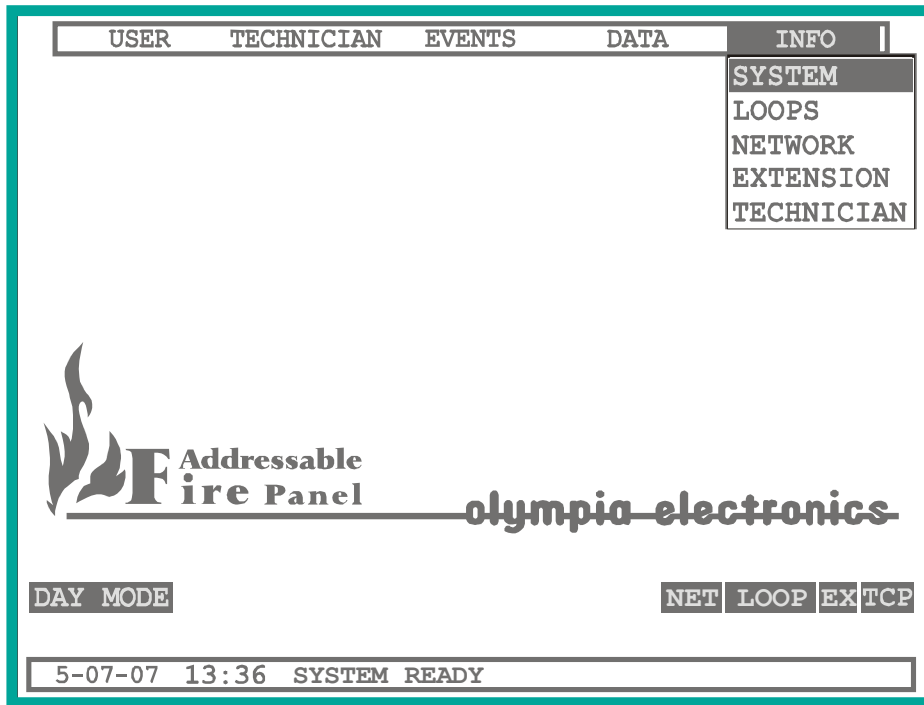

Figure 4-27 Information menu

Figure 4-28 shows a flow diagram of the menu.

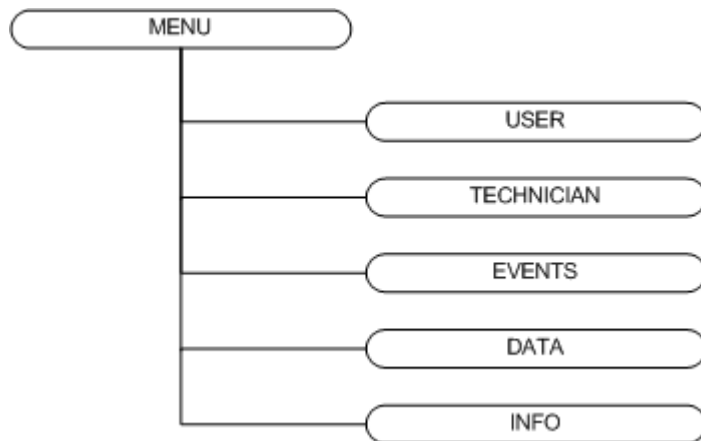

Figure 4-28 Information menu diagram

In the first selection «SYSTEM» we can see information about the system (figure 4-28).

The choice “NETWORK” is visible when the panel is master. In the menu, information about the panels in the network are displayed (more details in the next chapter).

The choice “EXTENSION” is visible when the panel is not repeater. A window with information about the extension is displayed in this menu (more details in the next chapter).



Date	9/7/2018
File	BSR-2114/MAR
Document Number	921211401_09_002
Page	52 από 74

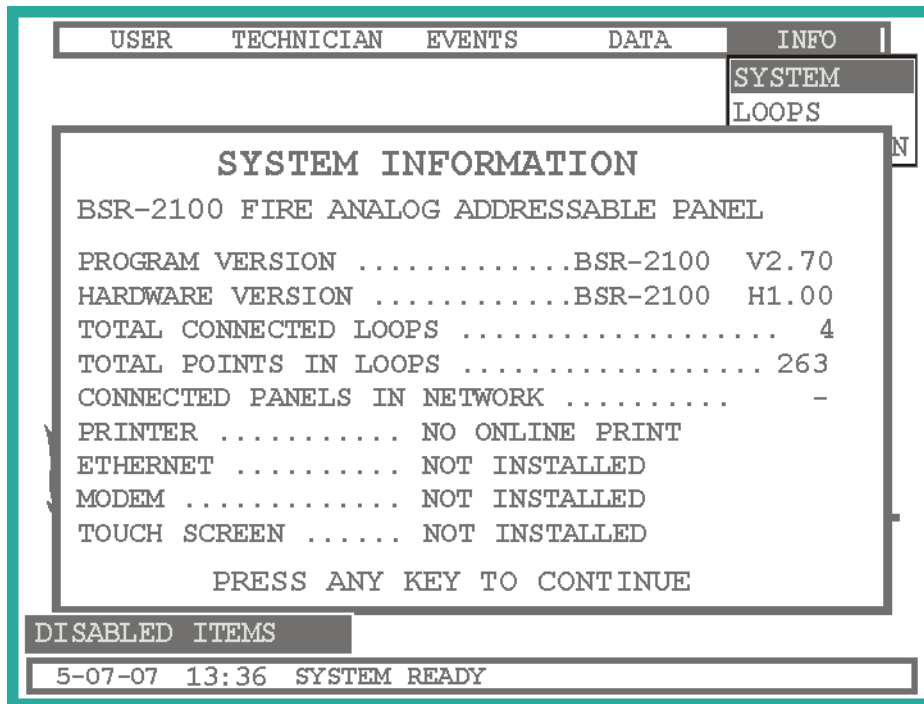

Figure 4-29 System information

We can see information for the following:

- **PROGRAM VERSION** : The firmware version of the main processor of the panel.
- **HARDWARE VERSION** : The hardware version of the system.
- **TOTAL CONNECTED LOOPS** : Shows the total number of loops connected to the panel.
- **TOTAL POINTS IN LOOP** : Show the total number of points connected to the panel.
- **CONNECTED PANELS IN NETWORK** : Shows the total amount of panels connected to the network.
- **PRINTER** : If a printer is available.
- **ETHERNET** : Shows if there is a capability to send data via internet.
- **MODEM** : Shows if there is a capability to send data via modem.
- **TOUCH SCREEN** : Shows the availability of a touch screen.

If a key is pressed then the window closes.

In the second selection «**LOOP**» we can see information concerning the loops of the system. The screen below shows the total amount of points connected to each loop. If a loop is not available then it is marked with a '- ' .

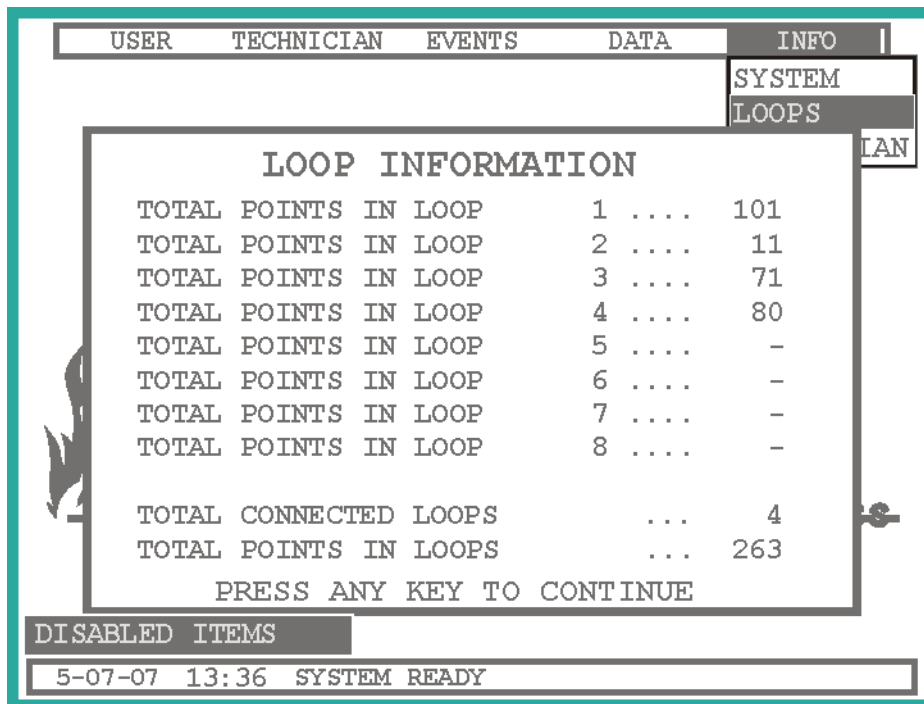

Figure 4-30 Loop information

If a key is pressed then we can view information regarding the firmware and hardware versions of each loop as shown below.

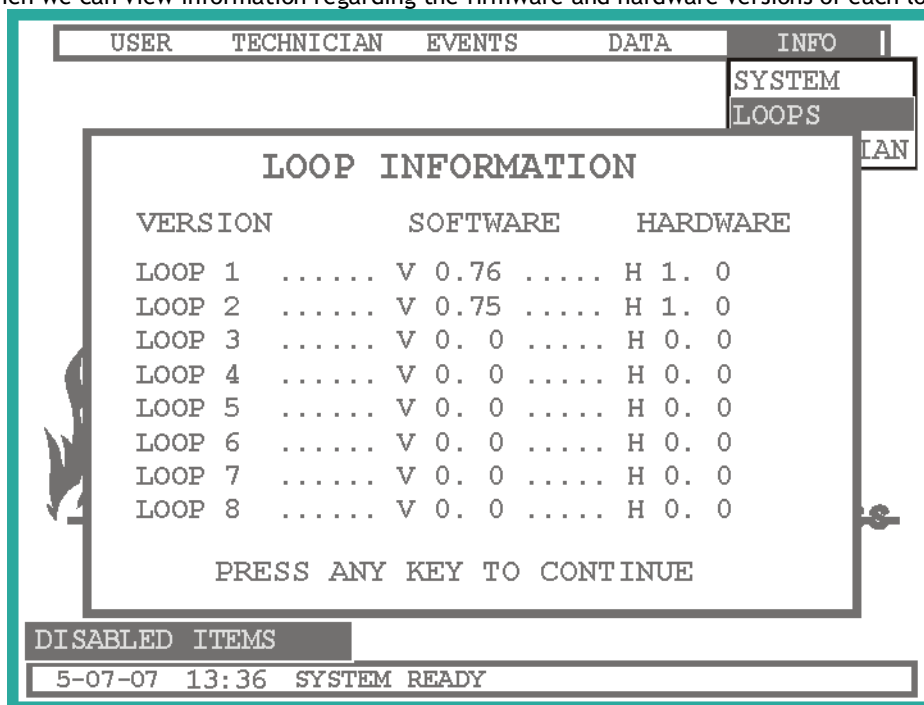

Figure 4-31 Loop information

If we select the «TECHNICIAN» option then we can view information regarding the technician (figure 4-32) . The technician can use this option to display information about himself (name and telephone) with a maximum of 32 characters.

Note. We cannot change the information from this menu item.

 olympia electronics <small>SAFETY & SECURITY SYSTEMS</small> <i>for a safer world!</i>	Date	9/7/2018
	File	BSR-2114/MAR
	Document Number	921211401_09_002
	Page	54 από 74

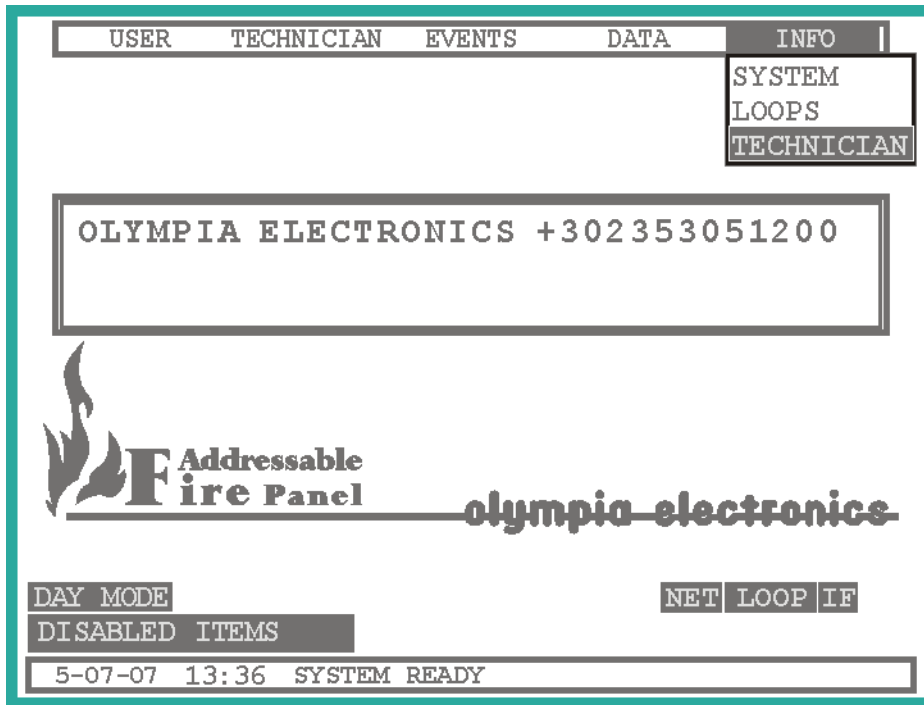

Figure 4-32 Technician information

Press any key to close the screen.



olympia
electronics
SAFETY & SECURITY SYSTEMS

for a safer world!

Date 9/7/2018

File BSR-2114/MAR

Document Number 921211401_09_002

Page 55 από 74

5 Technicians menu section

This section will reference the selections that a technician can do. (access level 3 and 4).

5.1 Access Codes.

Access levels '3' and '4' are used to access options that can control the panel in the event of a fire alarm or a fault condition. They are used also to get access to the options that program the panel. Due to these fact an access code is required.

The Access level 3 code is

ACCESS CODE FOR LEVEL '3'
ACCESS LEVEL 3
2333

Figure 5-1 Access code for level 3.

5.2 Technician menu

If we select the «TECHNICIAN» tab and press «ENTER» then a code request window will be shown. We must enter the code for access level 3. After entering the code the technicians menu will be available (figure 5-2).

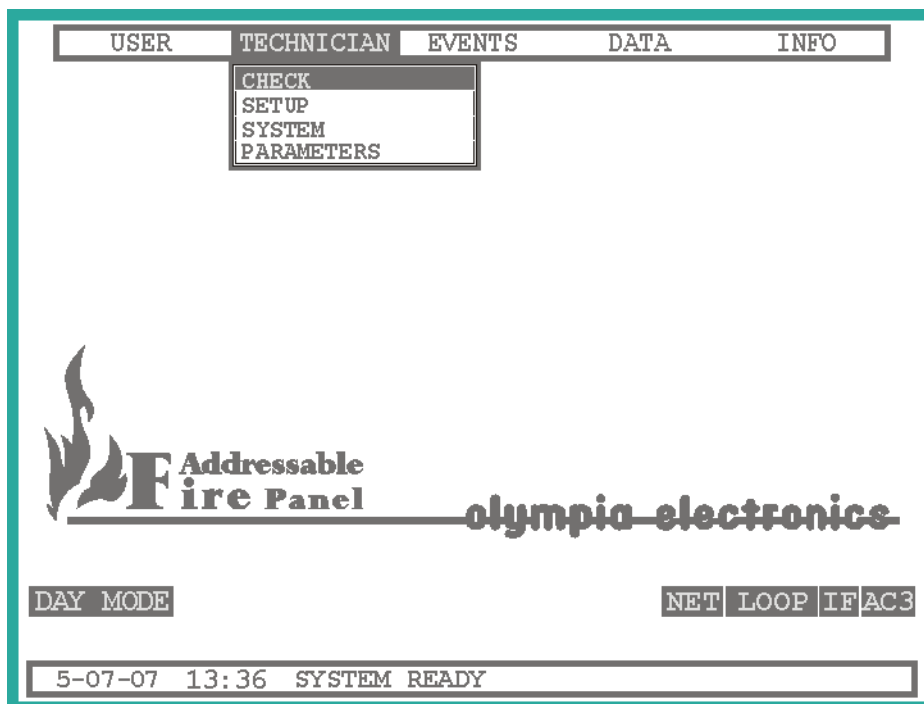

Figure 5-2 Technicians menu

As shown in the flow diagram below, the technician has many options that he can select.

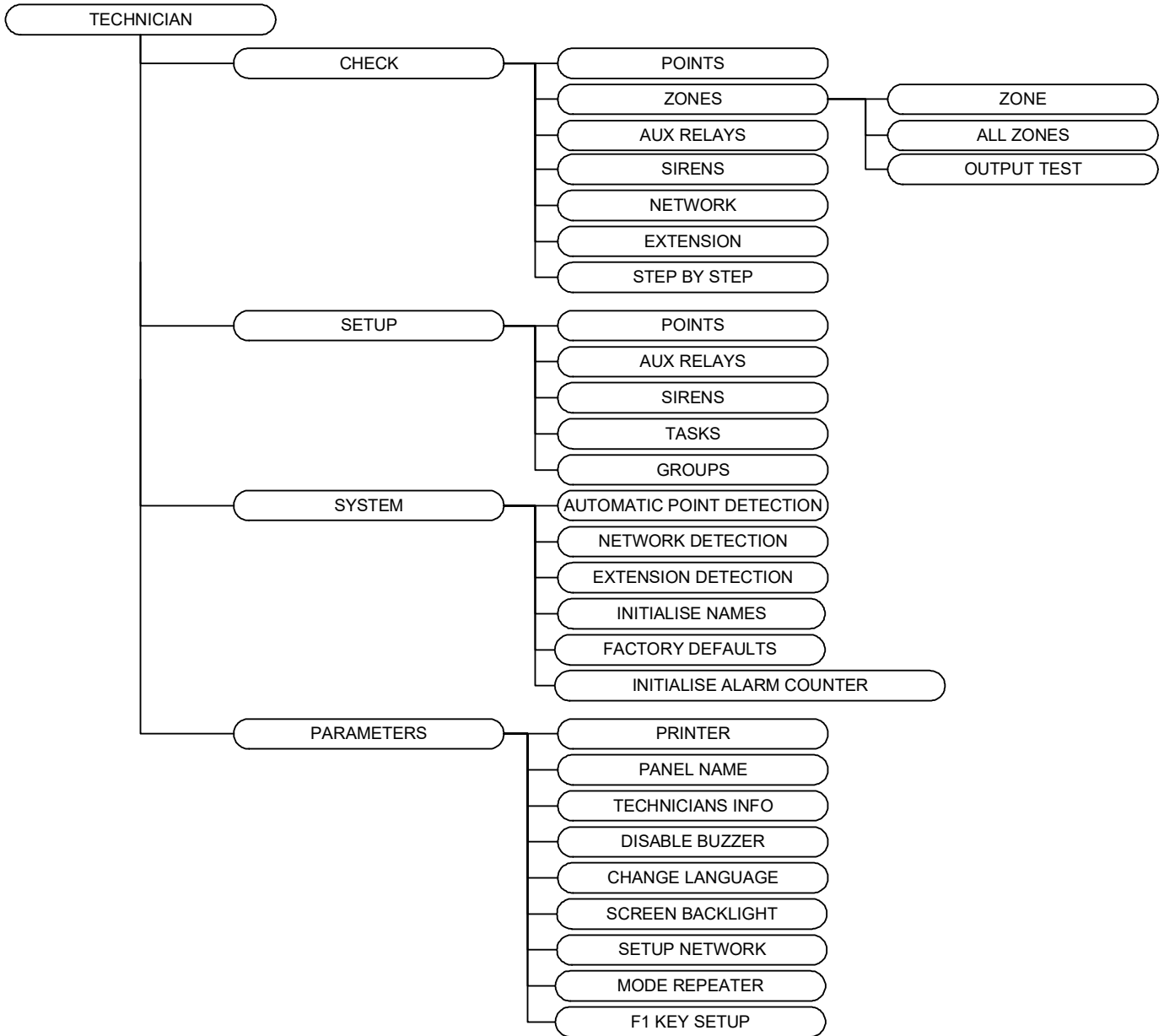

Figure 5-3 Technicians menu diagram

A detailed description of each option will follow.

5.3 Check menu

Using this option we can test the good operation of various devices that are connected to the panel.

Note : After exiting the menu the panel conducts a system reset.

5.3.1 Check - points menu

!! BE AWARE !! THIS OPTION IS NOT ACCORDING TO EN 54-2.

This selection permits us to test each point that is installed on the loop.

The figure below shows a typical screen for testing one point of the panel. (figure 5-4).

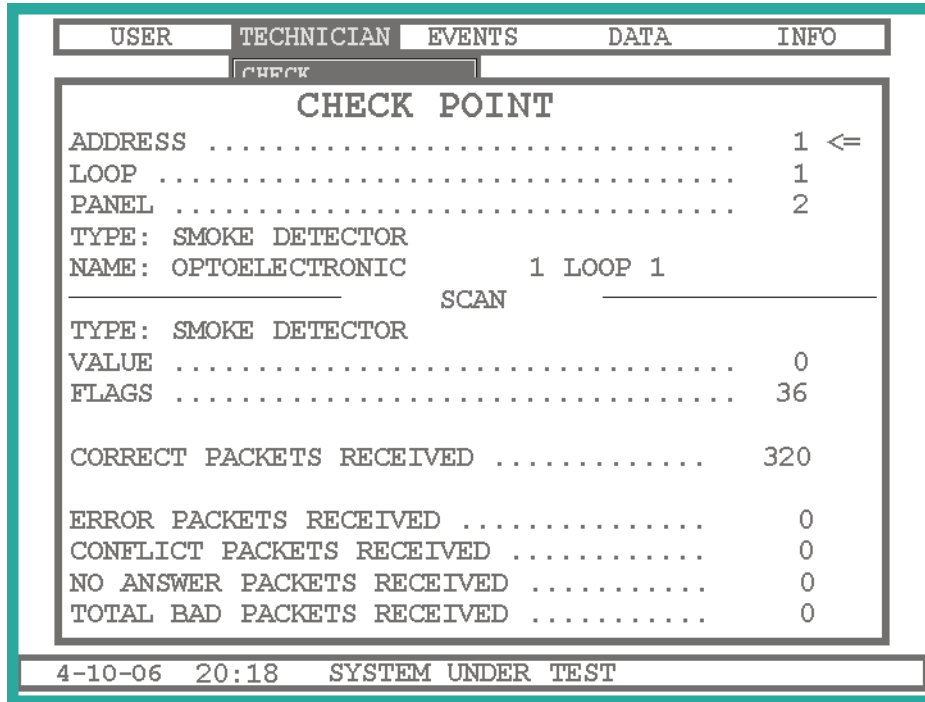

Figure 5-4 Point Testing

The address of the point is referenced in the first 3 lines and can be changed using the keys «LEFT» or «RIGHT» or by pressing the «ENTER» key.

The next 2 lines show the type and name of the installed point. If the point is not installed there is a “----“ beside the type.

In the next lines the panel refers to what it is reading from the loop and is the following:

- **TYPE** : The type of point on the loop.
- **VALUE** : The value that the point is reporting.
- **FLAGS** : meaningful only for the manufacturer.
- **CORRECT PACKETS RECEIVED** : Total amount of time that the panel communicated with the point successfully.
- **ERROR PACKETS RECEIVED** : How many times the panel receive data from the point with a wrong checksum.
- **CONFLICT PACKETS RECEIVED** : How many times the panel received data from the point with an incorrect format.
- **NO ANSWER PACKETS RECEIVED** : How many times the loop sends data and does not receive an answer.
- **TOTAL BAD PACKETS RECEIVED** : The total packets that come from the sum of the upper three categories.

5.3.2 Check Zones

With the option we can set or reset a zone to test mode. This menu has the below options:

- **ZONE** : Set or reset the test mode state of each zone.
- **ALL ZONES** : Set all zones to the mode.

- **OUTPUT TEST** : With this option enables the siren output for few seconds every time a alarm occurs in zone under test. **THIS OPTION IS NOT ACCORDING TO EN 54-2.**

5.3.3 Check - Auxiliary relay menu

With the option we can test the good operation of the 6 auxiliary relays. The figure below show a screen that is used to test one auxiliary relay.

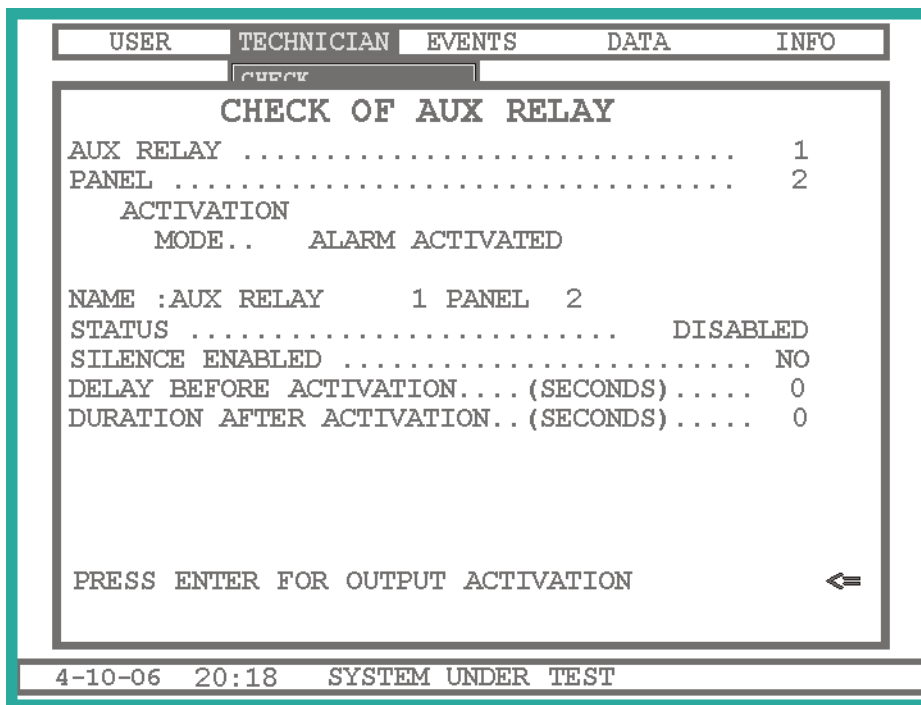

Figure 5-5 Auxiliary relay testing

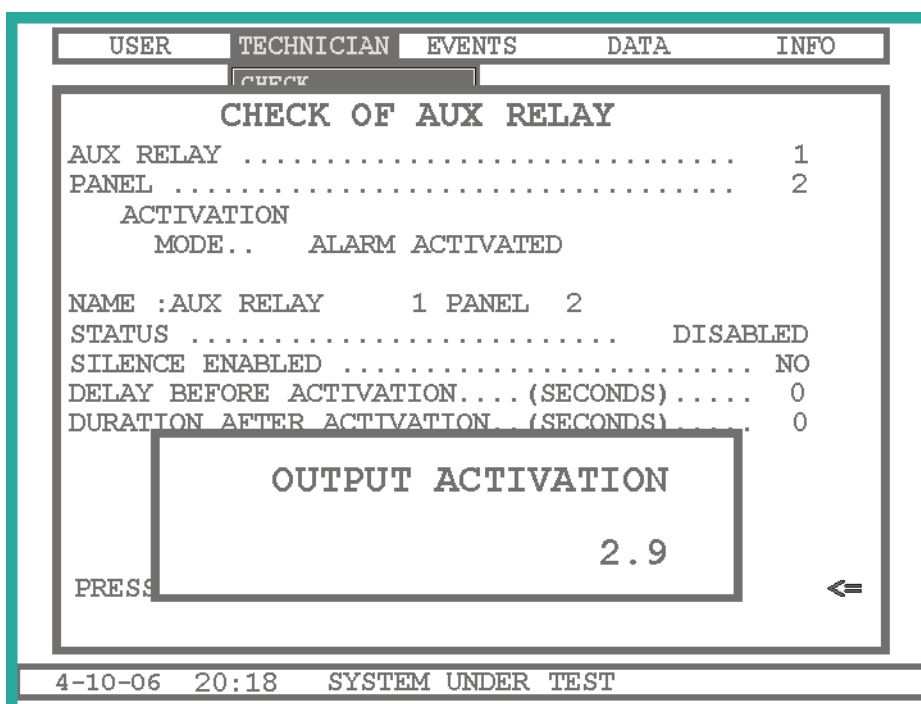

Figure 5-6 Activating the output

This screen shows the settings of the relay and can also be used to activate it. To activate the relay for 5 seconds we must move the arrow to point to the selection «PRESS ENTER FOR OUTPUT ACTIVATION » and then press «ENTER». A window is shown with the time that the relay will remain activated (figure 5-6).

5.3.4 Check - Siren menu

The option permits us to test the good operation of the sirens. The figure below shows a typical screen for testing one siren.

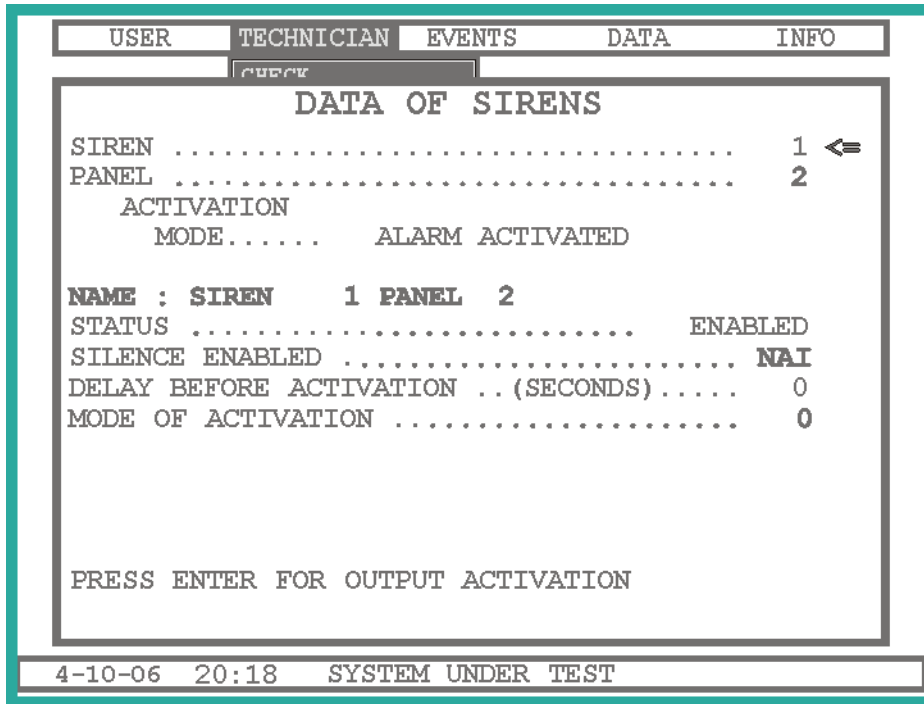

Figure 5-7 Siren testing

The screen shows us the settings of the siren and permits us to activate it. To activate the siren for 5 seconds move the arrow cursor to the option « PRESS ENTER FOR OUTPUT ACTIVATION » and press «ENTER». The siren is activated and a window is shown with the time that the siren will remain activated.

5.3.5 Check network

If the network is enabled this menu is available. With this menu we can check the quality of the network.

Below figure shows a typical screen of this menu.

5.3.6 Extension check

If the panel does work as repeater this menu is available. With this menu we can check the quality of the extension.

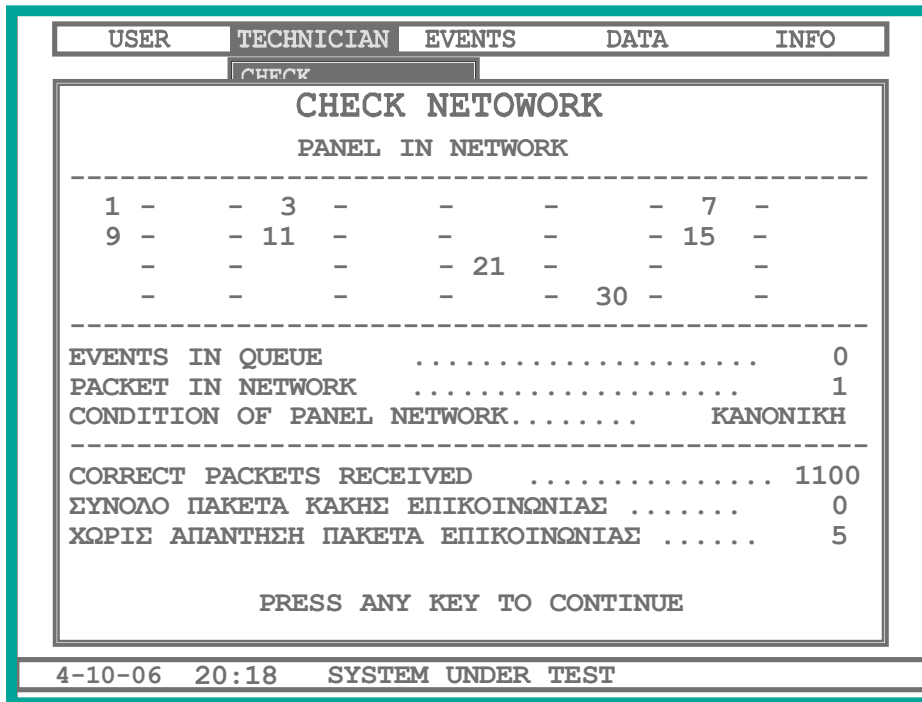

Figure 5-8 Network check

5.4 Setup menu

The option permits us to change the configuration of the elements of the panels such as points, sirens, relays, e.t.c.

Note : After exiting this menu the panel will conduct a system reset.

5.4.1 Setup - Points

This option permits us to change the configuration of any point that is connected to the panel. Figure 5-5 shows a typical point configuration screen.



Date	9/7/2018
File	BSR-2114/MAR
Document Number	921211401_09_002
Page	61 από 74

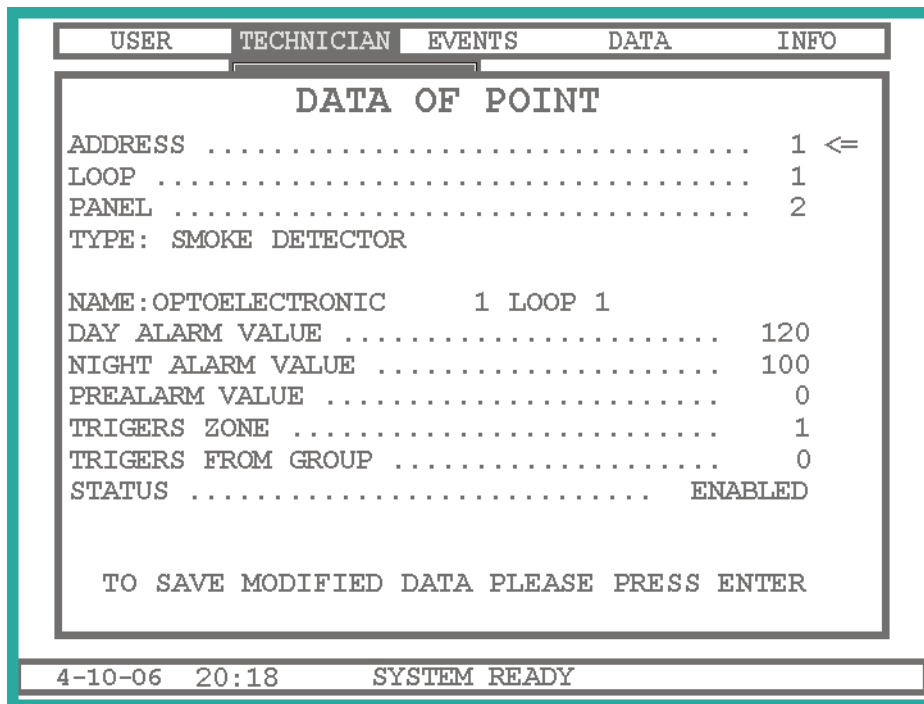

Figure 5-9 Point configuration.

Depending on the type of the installed point the screen shows the according settings. We can change the address or the loop by using the arrow keys «LEFT» and «RIGHT» . To set the setting press the «ENTER» key. The screen shows the following fields :

- **TYPE** : Describes the type of point. If no point is installed then this field has “-----“ markings.
- **NAME** : The name of the point with a total of 32 characters.
- **DAY TIME ALARM LIMIT** : The alarm value of the point during the day time. If this limit is exceeded during the day time an alarm is issued.
- **NIGHT TIME ALARM LIMIT** : The alarm value of the point during the night time. If this limit is exceeded during the night time an alarm is issued.
- **PRE-ALARM VALUE** : The pre-alarm value of the device. If this value is exceeded then the device gives a pre-alarm.
- **ACTIVATES THE ZONE** : When the sensors are activated it also activates the stated zone.
- **ACTIVATES THE GROUP** : When the sensors are activated it also activates the stated group.
- **STATUS** : The status of the point (if it is activated or deactivated).

Additionally, if the point is a siren or output it also has:

- **SILENCE CAPABILITY** : If YES is selected then the siren or output with silence with a command «SILENCE SIRENS» . If we select NO then they will not silence when the SILENCE SIREN key is pressed.
- **DELAY BEFORE ACTIVATION** : Delay before activation in seconds (1-240).
- **ACTIVATION METHOD** : Change the method of activation (0 to 4).
- **ZONE (1-96) FUNCTION (97-150)** : The siren or output are activated by a zone or a function or by a general alarm (if 0 is selected).

To change a setting of a point, move the arrow to show the setting that we want to change and then press «ENTER». If you require to change the type of the point move to the TYPE setting and press «ENTER» . The screen will show the following:

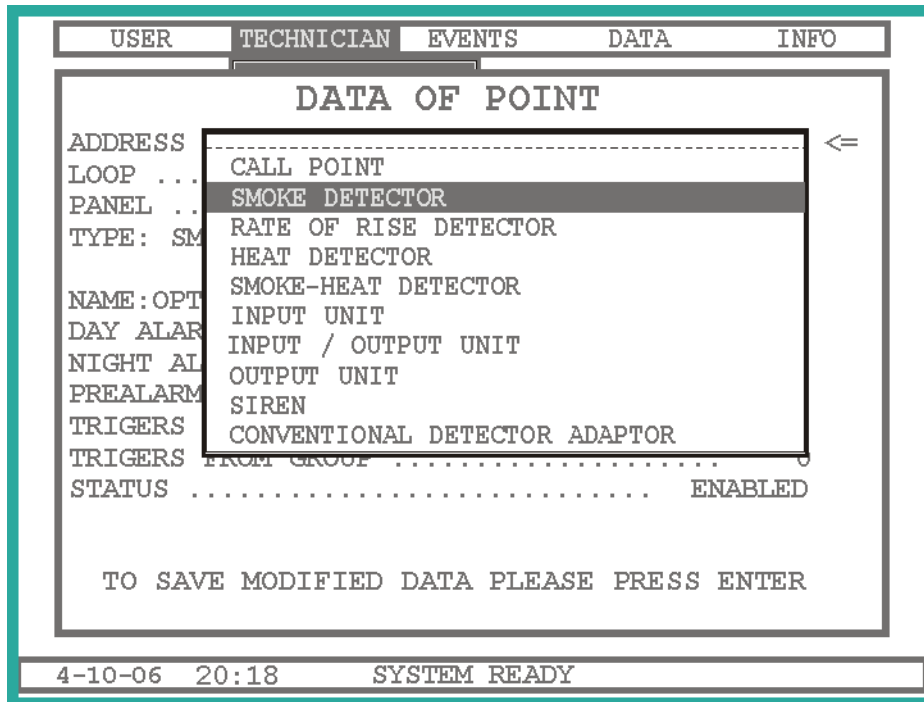

Figure 5-10 Selecting the type of point

This screen shows all the types of points that can be installed. (Note- The ---- denote that the point is not available). Select the required type by using the «DOWN» and «UP» keys and then press «ENTER» to confirm the selection. The screen that opens when we want to change the name of the point has the following image.

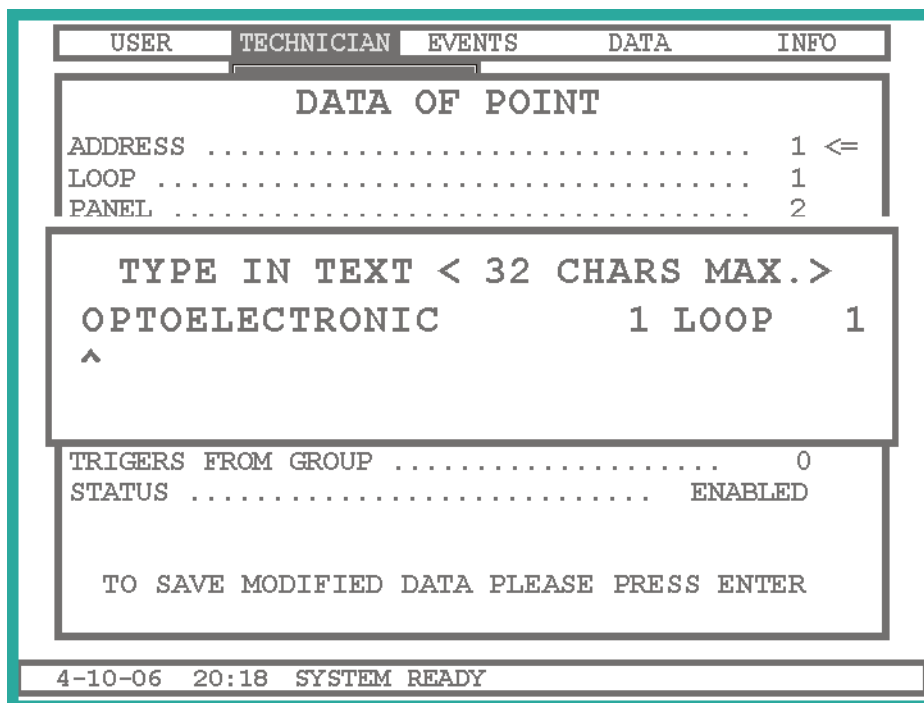

Figure 5-11 Changing the name of a point

The cursor is shows as a «^» and if we want to change any letter use the «LEFT» and «RIGHT» to place the cursors under the letter and then press the «UP» or «DOWN» keys until the desired letter is shown. To accept the changes press the «ENTER» key. To cancel the operations press the «ESC» key.



Date	9/7/2018
File	BSR-2114/MAR
Document Number	921211401_09_002
Page	63 από 74

The following window opens to change the status of a point. (figure 5-11).

USER	TECHNICIAN	EVENTS	DATA	INFO
DATA OF POINT				
ADDRESS				1 <=
LOOP				1
PANEL				2
TYPE: SMOKE DETECTOR				
NAME: OPTOELECTRONIC 1 LOOP 1				
DAY ALARM VALUE				120
NIGHT ALARM VALUE				100
PREALARM VALUE				0
TRIGERS ZONE				1
TRIGERS FROM GROUP				0
STATUS				ENABLED
TO SAVE MODIFIED DATA PLEASE PRESS ENTER				
4-10-06 20:18 SYSTEM READY				

Figure 5-12 Changing the status of a point



Date	9/7/2018
File	BSR-2114/MAR
Document Number	921211401_09_002
Page	64 από 74

5.4.2 Setup - Sirens

If Siren configuration is selected then a window is opened that permits us to select the siren that is to be configured. Select the required siren by using the «UP» and «DOWN» keys.

Figure 5-12 shows a typical siren configuration screen.

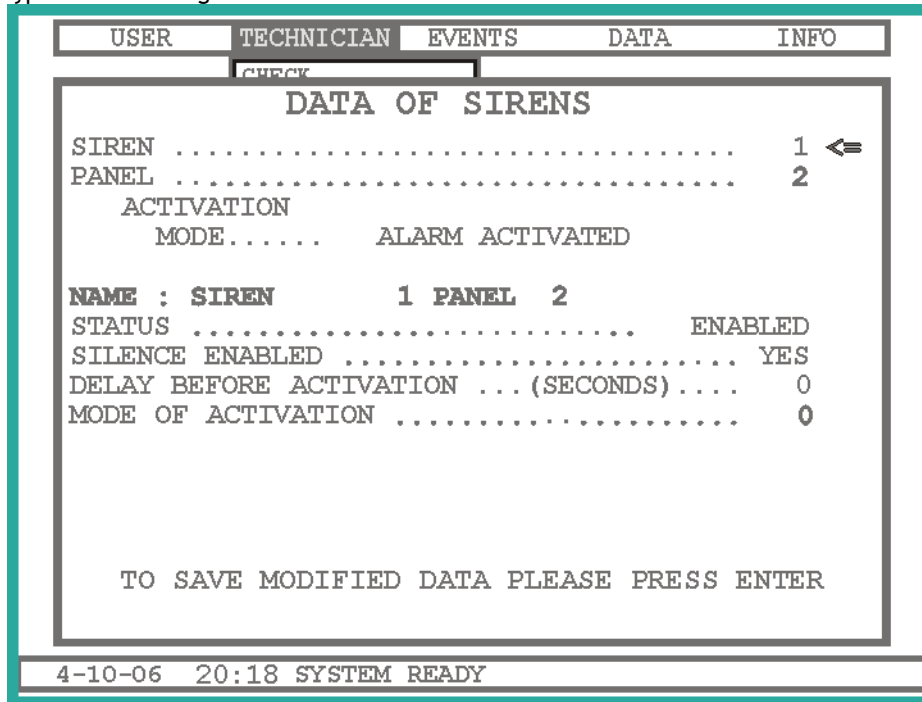

Figure 5-13 Siren configuration

In order to change the activation method, move the arrow to point to the setting «ACTIVATION METHOD» and press the «ENTER» key. A window will open with the following selections :

- **ACTIVATION WITH AN ALARM** : The siren is activated by a general alarm.
- **ACTIVATION FROM ZONES** : The siren is activated by a zone or a function.

Select the required option using the «UP» and «DOWN» keys and press «ENTER» to confirm the selection.

Additionally we can change :

- **NAME** : The name of the siren.
- **STATUS** : If the siren is enabled or disabled.
- **SILENCE ENABLED** : If YES is selected the then siren or output with silence with a command «SILENCE SIRENS» . If we select NO then they will not silence when the SILENCE SIREN key is pressed.
- **DELAY BEFORE ACTIVATION** : Delay before activation in seconds (1-240).
- **MODE OF ACTIVATION** : Change the method of activation (0 to 4).
- **ZONE (1-96) FUNCTION (97-150)** : The siren or output are activated by a zone or a function or by a general alarm (if 0 is selected).

Press the «ENTER» key to accept the changes or the «ESC» to cancel.

Finally to save all the changes that have been made to the siren configuration select «TO STORE CHANGES PRESS ENTER» and press the «ENTER» key.



Date	9/7/2018
File	BSR-2114/MAR
Document Number	921211401_09_002
Page	65 από 74

5.4.3 Setup - Aux relay

The configuration of the auxiliary relay is identical to the siren configuration. (see paragraph. 5.4.2).

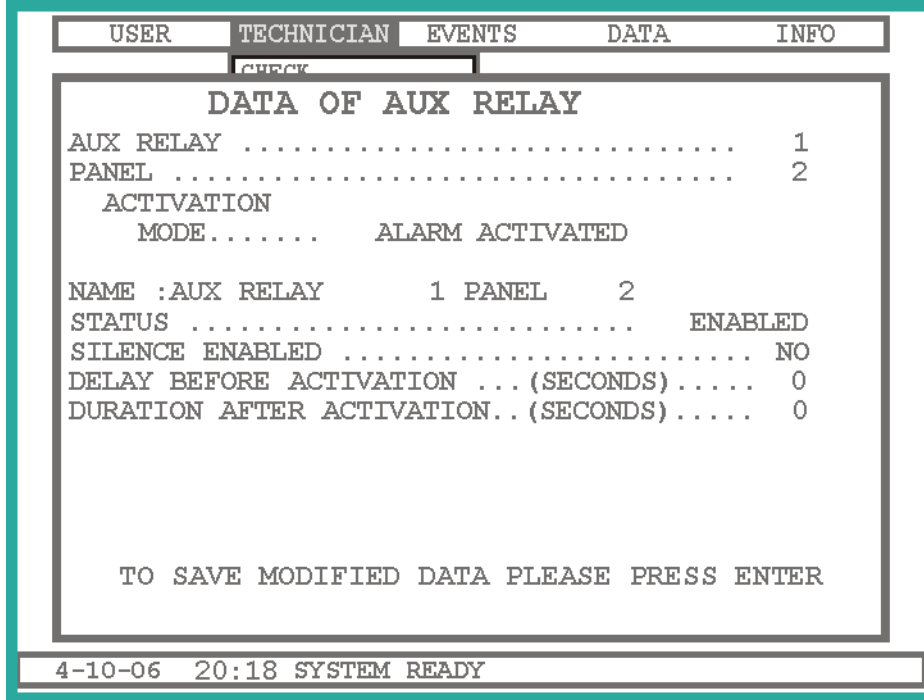

Figure 5-14 Auxiliary relay configuration.

THE OPTION DURATION AFTER ACTIVATION IS NOT ACCORDING TO EN 54-2.

5.4.4 Task setup

If we select the function configuration option, a window will open that will permit us to select which function we want to configure from 97 to 150. The function number is changed by using the keys «UP», «DOWN», «PAGE UP» and «PAGE DOWN». The figure below shows a typical function configuration screen.



Date	9/7/2018
File	BSR-2114/MAR
Document Number	921211401_09_002
Page	66 από 74

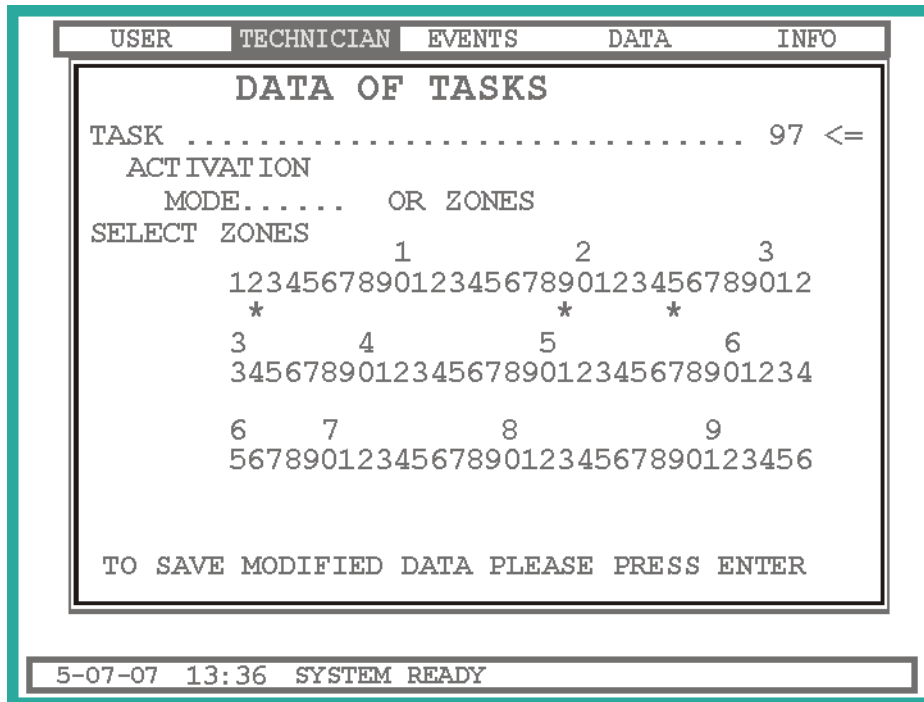

Figure 5-15 Function configuration

To change the activation mode move the arrow to point to «ACTIVATION MODE» and press «ENTER». A window opens with the following options :

- **ZONES (OR)** : The function is activated when any chosen zone is activated.
- **ZONES (AND)** : The function is activated when all chosen zones are activated.

Select the desired option using the «UP» and «DOWN» key and press «ENTER» to confirm the selection.

To change the selected zones move the arrow to point to «ZONE SELECTION» and press «ENTER». A window will open with all the zones. Move the cursor «^» under the zone that is required using the «LEFT» and «RIGHT» keys and select the zone by pressing the «UP» key. This places the zone into the group. When this is done an asterisk is shown over the cursor.

While exiting press «ENTER» to save the changes. If «ESC» is pressed then no changes are stored.

Finally to store the changes we have made in the function configuration move the arrow to point to «TO STORE CHANGES PRESS ENTER» and press the «ENTER» key.

5.4.5 Setup - Groups

If we select the group configuration option then a window will open that will permit us to select which group we want to configure. The group number can be changed using the «UP» ,«DOWN», «PAGE UP» and «PAGE DOWN» keys.

The figure below shows a typical configuration screen.

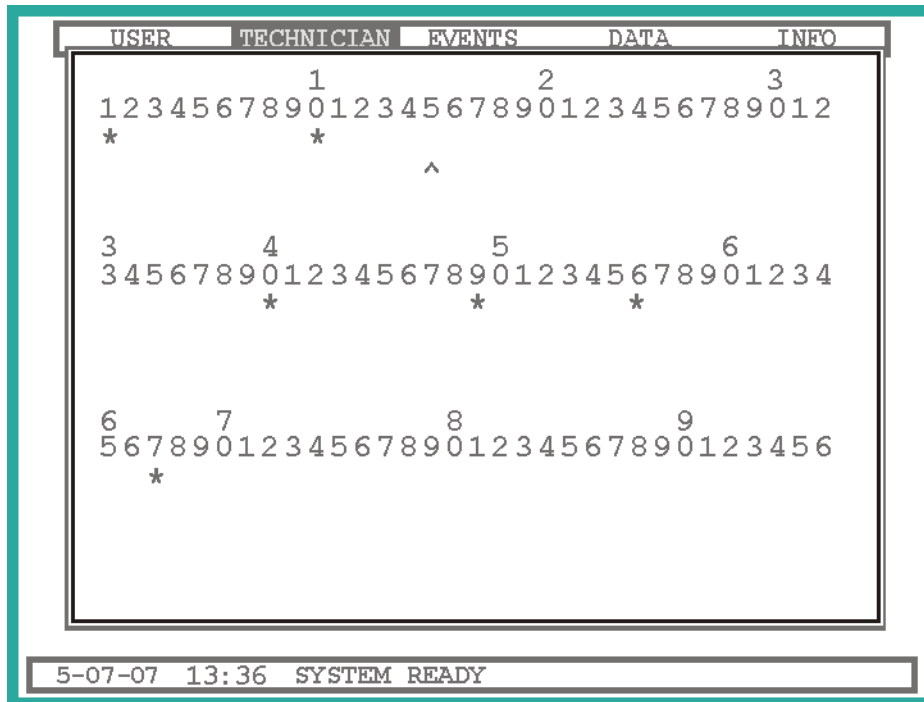

Figure 5-16 Group configuration

If we want to place a zone in a group place the cursor «^» under the zone using the «LEFT» and «RIGHT» and then press the «UP» key to insert the zone into the group. After that an asterisk is shown over the cursor. While exiting press «ENTER» to store the setting or «ESC» to cancel.

5.5 System menu

5.5.1 Automatic Point detection

This menu permits us to automatically search for loops and points that are connected to the panel. As shown in the figure below, the screen shows which point is been searched, how many points have been found and which was the last one that was found.

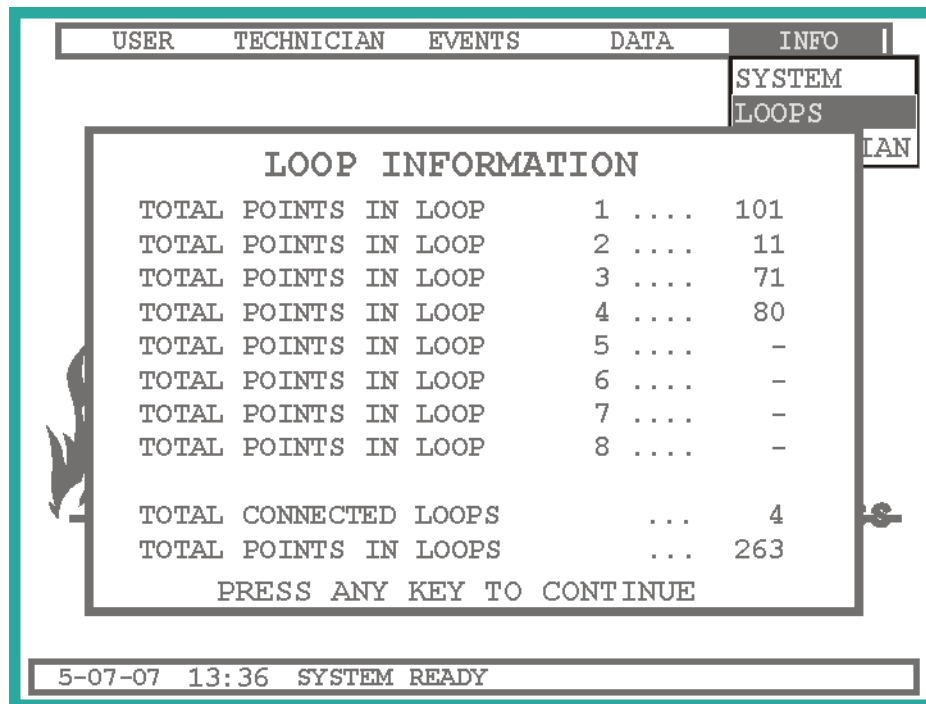

Figure 5-19 End of point recognition.

After point recognition has finished the screen will show information about the loops and after a while the panel will conduct a system reset (figure 5-19).

5.5.2 Network detection

If the panel is master (panel address 1) is choice is available. With this menu a network detection take place.

5.5.3 Extension detection

If the panel does not work as repeater this choice is available. Pressing «ENTER» an extension detection take place.

5.5.4 Initialize names

With this option the panel resets all the point names and elements of the panel to the factory defaults. After that the panel conducts a full system reset.

5.5.5 Factory defaults

With this option the panel is set using the factory default setting as described in paragraph 6.1. After that the panel conducts a full system reset.

5.5.6 Initialize alarm counter

This option clears the alarm counter. The alarm counter is a counter that counts the alarms and does not clear. The counter clears only with this option.

To initialize the alarm counter you must be in access level 4. The access level is accessed when you are in access level 3 and the dip switch 4 of SW1 is ON on BOARD I/O. Otherwise you can not initialize the counter.

5.6 Parameters menu

Using this option we can adjust various parameters of the panel such as :

- **PRINTER** : declare if we want the printer to print the events immediately.
- **PANEL NAME** : Set the panel name (up-to 32 characters).
- **TECHNICIANS INFO** : Set the technicians name (up to 32 characters).
- **DISABLE BUZZER** : Using this option we can disable the internal buzzer. Please note that this does not conform to EN54-2 regulations.
- **CHANGE LANGUAGE** : Use this option to change the language as described in paragraph 2.2.1.
- **SCREEN BACKLIGHT** : Select if the screen backlight is always on or not. If we select the backlight to be always on then the panels backup duration is degraded.
- **INDICATION OF PANEL** : Use this option to mark the panel as a LOCAL panel or a NETWORK PANEL

5.6.1 Network setup

The parameters of the network can be changed by this menu, a typical screen is shown below:

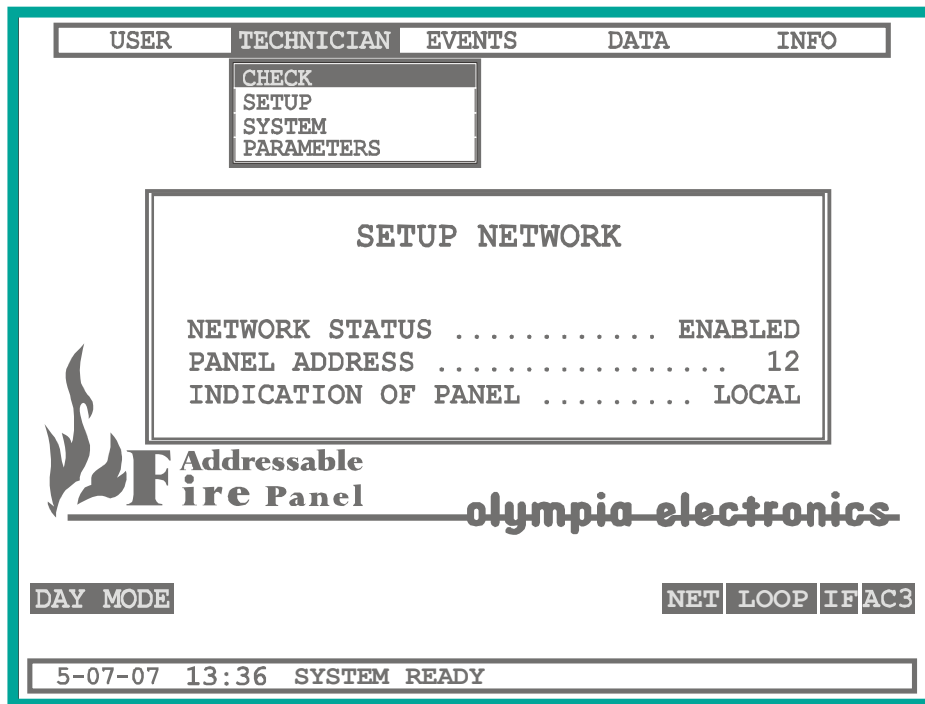

Figure 5-20 Network setup

The parameters are :

- **NETWORK STATUS** : if the network is enabled or disabled. If the arrow is at this choice and we press «ENTER» we can change the status.
- **PANEL ADDRESS** : The address can be set from 1 up to 32. If the address is 1 the panel is master else the panel is subpanel. If the arrow is at this choice and we press «ENTER» we can change the address.
- **INDICATION OF PANEL** : The panel can show only its indication or the indication of the master panel.

If we want to exit this menu we press «ESC» and then we select “YES” so the changes are saved.

5.6.2 Mode repeater

As the previous paragraph, here we change the parameter of the repeater mode:

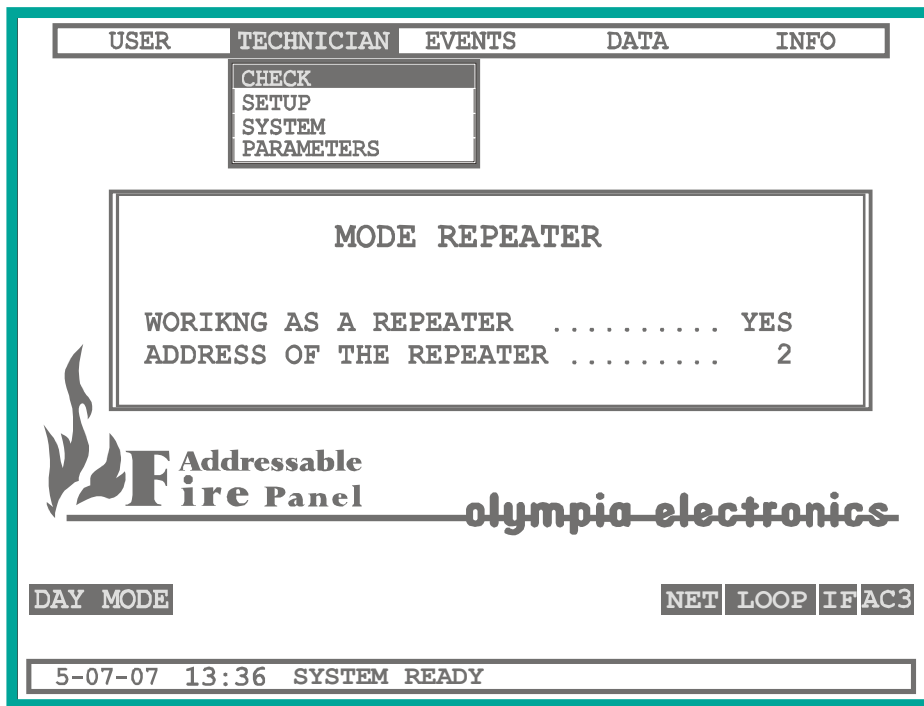

Figure 5-21 Repeater mode

The parameters are:

- **WORKING AS REPEATER** : If the “YES” is displayed the panel works as repeater, else if “NO” is displayed the panel can take repeater panel in the extension.
- **ADDRESS OF REPEATER** : If the panel is repeater we can set its address from 1 to 4.



6 Technical characteristics section

6.1 Factory defaults

Table 6-1 Factory default settings

Loops	No loop is installed
Points	No point is installed They are named with the following format «POINT 1 LOOP 1 PANEL 1»
Sirens	All sirens are enabled and are activated with a general alarm. Their delay and duration are set to 0.
Auxiliary relays	All auxiliary relays are enabled and are activated with a general alarm (except relay which is activated with general fault). Their delay and duration are set to 0.
Groups	All groups do not contain zones
Functions	All functions do not contain zones and their method of activation is by ZONES (OR).
Disablements	All systems are enabled
Work hours	05:00 - 18:00
Work days	Monday, Tuesday, Wednesday, Thursday, Friday
Printer	Disabled
Additional relay	Not installed
Panel address	2
Disable buzzer	Disabled
Screen backlight	Not continuous

6.2 Option of EN 54-2

This panel also includes the below options with requirements of EN 54-2

Table 6-2 Options with requirements EN 54-2 including in the panel

Paragraph	
7.8	Output to fire alarm device(s)
7.9.1	Output to fire alarm routing equipment
7.10.1	Output type A
7.10.4	Fault monitoring of fire protection equipment
7.11	Delays to outputs
7.13	Alarm counter
8.3	Fault signals from points
8.9	Output to fault warning routing equipment
9.5	Disablement of each address point
10	Test condition



6.3 Characteristics

Table 6-3 Characteristics

	BSR-2104/MAR	BSR-2114/MAR
	2-4 loop, 96 zone addressable fire detection panel.	
Power supply	220-240V AC/50-60Hz	
Fuse rating	2A-250VAC (slow blow) 5x20mm	
Consumption	100 VA	
Battery type	2x Sunlight SP-12 12V (7Ah or 12Ah) Lead Acid	
Maximum current consumption from battery	2.4A	
Maximum Battery resistance	1ohm	
Charge circuit	Stabilized power supply 27.6V / 600mA	
Loop circuit	24V up to 200mA(quiescent state). Each loop can accept up to 150 points. Each loop is protected with a self-resetable fuse. The maximum number of fire detectors and manual call points connected to a panel must not exceed 512.	
Loop protocol	The communication protocol of the panel to the sensors (devices) is an Olympia Bus protocol. The only devices connected to the loop must be manufactured by Olympia Electronics SA.	
Siren circuit	4 circuits 24V/500mA, monitored for open and short circuits. Each output is protected with a self-resetable fuse.	
Output Vout	24VDC (+- 4VDC+-ripple 1V peak to peak) continuous output with max current 0,5A. Each output is protected with a self-resetable fuse.	
Relay4, Relay5, Relay6	General purpose relay (250VAC 5A).	
Relay1, Relay2, Relay3	Monitored relay output for open or short circuits. Each output is protected with a self-resetable fuse.	
Output Fault	Open collector output (max 30VDC/6mA)	
Output Alarm	Open collector output (max 30VDC/6mA)	
Outputs A1,A2 and A3	3 general purpose inputs (max. input voltage 30VDC)	
Total loads (Imax)	The total load on the (loops, sirens, outputs VOUT, relay) must not exceed 2A. Imax.a=Imax.b= 2A.	
Safe State	<p>The safe state for the main cpu of BSR-2100 is :</p> <ul style="list-style-type: none"> • The leds remain at the state that they were before the safe state. Except System fault which is on, and General Fault which light continuously or blink. • The relay outputs also remain at the state that they were. Except Fault relay output which is de-energized. • There is no communication with the loops. • Buzzer sounds. <p>The safe state for the loop cpu of BSR-2100 is :</p> <ul style="list-style-type: none"> • Shuts down the power of the loop. • Shuts down the power of the alarm devices (Sirens) • There is no communication with the main mcu. • Fault relay output is de-energized. • General Fault which light continuously or blink • Buzzer sounds 	
Connection cables	<p>The connection cables must be certified for fire detection installations such as FIP200, MICC, PYROFIL.</p> <p>The connection cables that are used for data transfer must be of the twisted pair type and must have insulation.</p>	
Cover protection	IP 30	
Operating temperature	-5 to 40 °C	
Humidity	Up to 95% relative humidity	

 	Date	9/7/2018
	File	BSR-2114/MAR
	Document Number	921211401_09_002
	Page	74 από 74

Construction materials	Electrostatically painted steel
Dimensions	480 x 410 x 154 mm
Weight	7 Kgr (2 loop), 7,2 Kgr(4 loop)
In accordance with	EN 54-2, EN-54-4, IEC 60092-504, IEC 60533
Warrantee	2 years

WARRANTY

Olympia Electronics guarantees the quality, condition and operation of the goods. The period of warranty is specified in the official catalogue of Olympia Electronics and also in the technical leaflet, which accompanies each product. This warranty ceases to exist if the buyer does not follow the technical instructions included in official documents given by Olympia Electronics or if the buyer modifies the goods provided or has any repairs or re-setting done by a third party, unless Olympia Electronics has fully agreed to them in writing. Products that have been damaged can be returned to the premises of our company for repair or replacement, as long as the warranty period is valid. Olympia Electronics reserves the right to repair or to replace the returned goods and to or not charge the buyer depending on the reason of defection. Olympia Electronics reserves the right to charge or not the buyer the transportation cost.

HEAD OFFICE

72nd klm old highway Thessaloniki-Katerini,
P.O. 60061 Kolindros, Pieria Greece

www.olympia-electronics.gr

info@olympia-electronics.gr