

CENTRAL BATTERY SYSTEM (CBS) EMERGENCY LUMINAIRES WITH WHITE LEDs



TECHNICAL CHARACTERISTICS (for LED MODULE Specs. see page 3)

	GR-296/30L/CBS/230V	GR-296/60L/CBS/230V
OPERATION VOLTAGE	60-250V DC, 100-250V AC/50-60Hz	80-250V DC, 130-250V AC/50-60Hz
MAXIMUM POWER CONSUMPTION	2.9W / 3.3VA	5.2W / 5.6VA
ILLUMINATION SOURCE	30 white LEDs	60 white LEDs
ILLUMINATION	255lm	510lm
DEGREES OF COVER PROTECTION	IP40	
PRODUCED IN ACCORDANCE WITH	EN 60598-1, EN 60598-2-22, EN 55015, EN 61547, EN 61000-3-2, EN 61000-3-3	
OPERATION TEMPERATURE RANGE	-30 to 50 °C	
RELATIVE HUMIDITY	Up to 95%	
CONSTRUCTION MATERIALS	Bayblend FR3010, transparent polycarbonate	
EXTERNAL DIMENSION	Ø125 x 65 mm	
TYPICAL WEIGHT	270gr.	
GUARANTEE	3 years	

**Thank you for your trust in our products.
Olympia Electronics - European manufacturer.**

GENERAL

These luminaires are used in places where emergency luminaires (CBS) are needed. Each luminaire must be permanently connected to mains power supply.

INSTALLATION

To install the luminaire follow the installation procedure as described below.

ATTENTION!!!

1. Operations for installation, maintenance

or testing must be done by authorized personnel only.

2. The device must be connected to the mains power supply through a fuse dependent by the total amount of the line's power load.

NOTE: LED= Light Emitting Diode

LABELING EXPLANATION:

Z: Central supply

1: Maintained

INSTALLATION INSTRUCTIONS

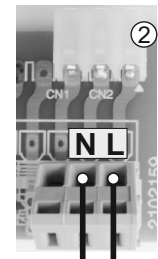
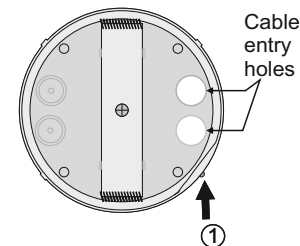

AC/DC power supply

Initial installation

- ① Untighten the screw but do not remove it and pull up the reflector.
- ② **Always use in any case round mains cable, with a diameter of 5-10mm (H05RN-F type 2x1mm² or any other type, at least equal to it's mechanical and electrical properties). ATTENTION!! The cable must not be deformed in any way (This requirement is important to ensure the IP rating).** Install the included gaskets in to the cable entry holes (*verify that are not deformed*). Make a hole in the center by using a small screwdriver. Pass the round cable through the gasket. Connect the wires as shown on the picture (no polarity is required).
- ③ Refit the reflector (mind the correct orientation), tighten the screw securely and the luminaire is ready for mounting.

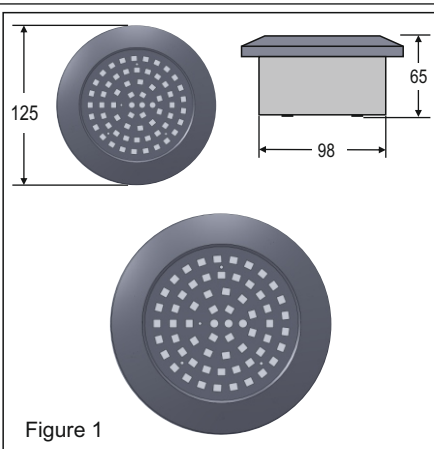

Figure 1

Mounting the lamp in suspended ceiling.
 Set up the lamp to the suspended ceiling as it is shown below (Required opening 110mm):
Step 1
 Bend the springs, to get into the hole of the suspended ceiling, as you can see to the next figure.

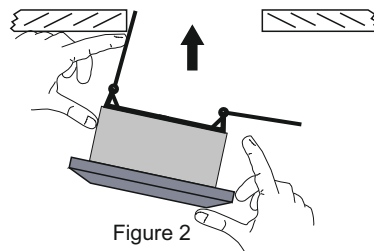

Figure 2

Step 2
 Push up the luminaire, as shown in figure 3.

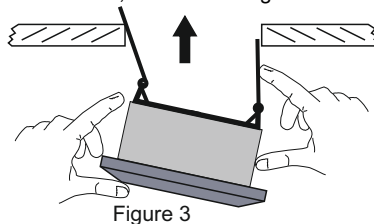

Figure 3

Step 3
 Continue to push upwards and the lamp locks.

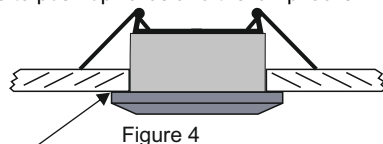

Figure 4

If you want to pull off the device, put a flat blade screwdriver, between the device and the ceiling.

Surface mounting.

Install the luminaire according to the following steps:

Step 1. Follow the step 1 and 2 of the installation instructions.

Step 2. Unfasten the retaining screw (Figure 1) and detach the part for suspended ceiling installation.

Step 3. Drill 2 holes on the base using a 4mm drill bit in order to permit the retaining screws to pass. Mark these two drilled points on the required mounting location, drill the holes and install the supplied plastic plugs.

Step 4. Install the decorative rim (package included). Next, use the 2 fasteners to install the unit to the require location.

Step 5. Follow the step 3 of the installation instructions.

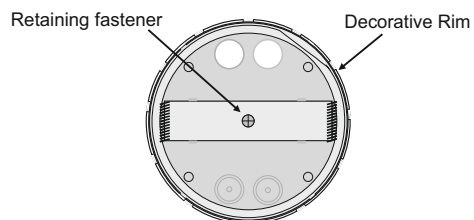

Figure 1

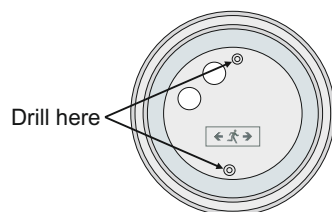

Figure 2



The light source contained in this luminaire shall only be replaced by the manufacturer, or his agent, or a similar qualified person.

NOTE! The light source is non-user replaceable.

LED MODULE CHARACTERISTICS		
	GR-296/30L/CBS/230V	GR-296/60L/CBS/230V
Manufacturer	Olympia Electronics S.A	
Model Number	0402159	
Voltage Range	14.5-18V DC	
Nominal Power	1.95W	3.9W
Connections	Non reversible connection between main pcb and led module	
Temperature (tc)	45 °C max. across the board	50 °C max. across the board

WARRANTY

Olympia Electronics guarantees the quality, condition and operation of the goods. The period of warranty is specified in the official catalogue of Olympia Electronics and also in the technical leaflet, which accompanies each product. This warranty ceases to exist if the buyer does not follow the technical instructions included in official documents given by Olympia Electronics or if the buyer modifies the goods provided or has any repairs or re-setting done by a third party, unless Olympia Electronics has fully agreed to them in writing. Products that have been damaged can be returned to the premises of our company for repair or replacement, as long as the warranty period is valid.

Olympia Electronics reserves the right to repair or to replace the returned goods and to or not charge the buyer depending on the reason of deflection. Olympia Electronics reserves the right to charge or not the buyer the transportation cost.

HEAD OFFICE

72nd km. O.N.R. Thessaloniki-Katerini
 P.C. 60300 P.O. Box 06 Eginio Pierias Greece

www.olympia-electronics.gr

info@olympia-electronics.gr