



LED önlem işaretleri paneli

Olympia Electronics tarafından dünya çapında COVID19 pandemisinden sonra geliştirilen yenilikçi çözümler.

3 modelden oluşan yeni Covid Light LED önlem işaretleri tabelaları, çeşitli iş alanları ve kalabalık alanların tüm gereksinimlerini karşılar.

Modern stili ve bağlantığı kolaylığı ile Covid Light serisi, pandemi nedeniyle halk sağlığını koruma amaçlı önlem işaretlerinin gerekli olduğu her alan için idealdir

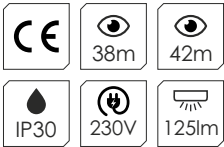

European
manufacturer



www.olympia-electronics.com



est. 1979

**olympiaTM
electronics**

SAFETY & SECURITY SYSTEMS

for a safer world!



LED ÖNLEM İŞARETLERİ TABELALARI COVID LIGHT

Lamba
LED

Yapısal malzemeler
Bayblend Fr3010, alüminyum, pleksiglas

Uygulamalar

Alışveriş merkezleri, mağazalar, havaalanları, okullar, fabrikalar, ofisler, kamu hizmetleri binaları gibi kalabalık alanlar.

Kurulum

COV/44/EM: Single sided sign suitable for wall or ceiling mounting, surface pendant or parallel mounting with the included accessories. Accessories suitable for hanging on a suspended ceiling or wall flag mounting available upon request.

COV/44/DZ: Double sided sign suitable for wall or ceiling mounting, surface wire suspended mounting with 50 cm wire or recessed ceiling mounting in false ceilings with the included accessories. The sign is suitable for placement in spaces with high ceilings.

COV/44/SP: Double sided sign suitable for wall or ceiling mounting, surface pendant mounting or recessed ceiling mounting in false ceilings with the included accessories.

Piktogramlar

COV/44/EM: Pictograms with 42m viewing distance for single sided sign.

COV/44/SP & COV/44/DZ: Pictograms with 38m viewing distance for double sided sign.

The package contains 3 pictograms of different markings to meet the needs that have been created after the COVID19 pandemic. Pictograms on COV-44/EM/MAR are easily placed over the transparent diffuser without the use of glue.



COV-44/EM için cm cinsinden boyutlar

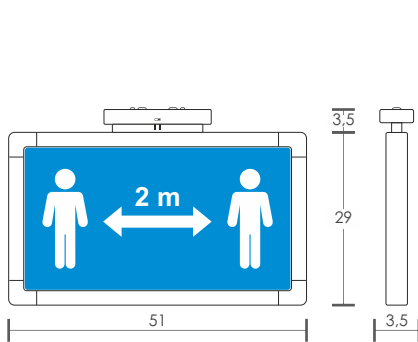

COV-44/SP & COV-44/DZ için cm cinsinden boyutlar

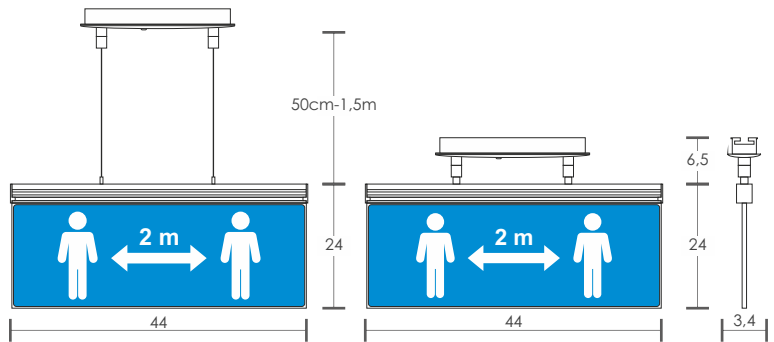

Güç kaynağı

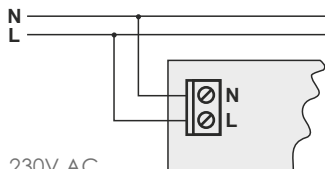

230V AC
Çıkarılabilir taban ile
kolay bağlantı

Ambalaja dahil olan piktogramlar

| KOD | AÇIKLAMA | RESİM |
|-----------|---|-------|
| 804940000 | CW-44/1,5 önlem amaçlı 1,5m mesafe tutulması zorunluluğu işaretli yüzey | |
| 804940001 | CW-44/2 önlem amaçlı 2m mesafe tutulması zorunluluğu işaretli yüzey | |
| 804940002 | CW-44 önlem amaçlı 2m mesafe, maske ve dezenfektan kullanımı zorunluluğu işaretli yüzey | |

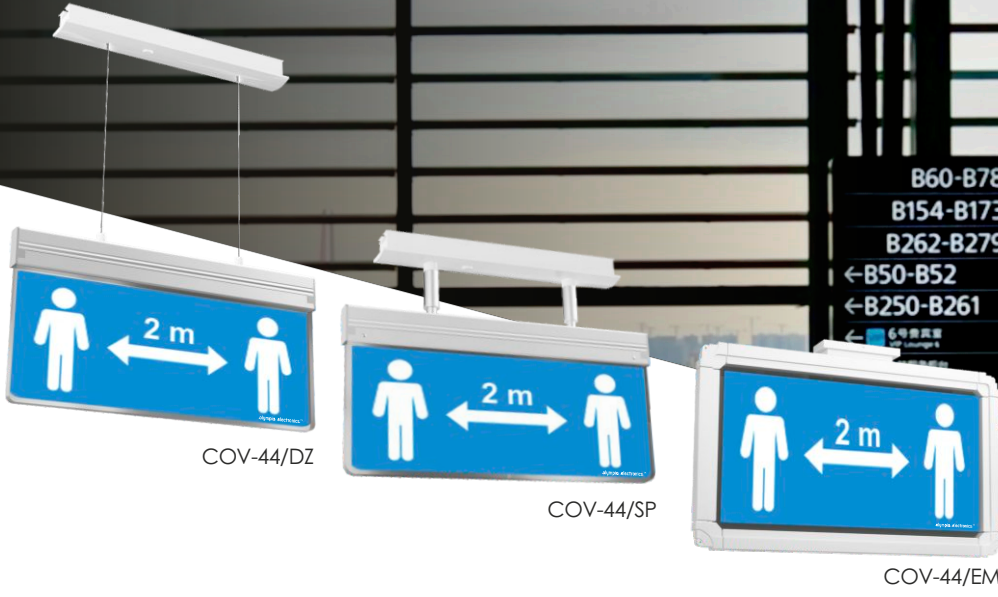

| KOD | AÇIKLAMA | MONTAJ YÖNTEMİ | GÖRÜŞ MESAFESİ |
|-----------|---|---|----------------|
| 922804450 | COV-44/EM, IP30, LED Güvenlik önlemleri işaretleri tabelası, 230V, single sided | Wall or ceiling mounting, surface pendant or parallel mounting with the included accessories. Accessories suitable for hanging on a suspended ceiling or wall flag mounting upon request. | 42m |
| 922804451 | COV-44/DZ, IP30, LED Güvenlik önlemleri işaretleri tabelası, 230V, double sided | Wall or ceiling mounting, surface wire suspended mounting with 50 cm wire or recessed ceiling mounting in false ceilings with the included accessories. Sign suitable for placement in spaces with high ceilings. | 38m |
| 922804452 | COV-44/SP, IP30, LED Güvenlik önlemleri işaretleri tabelası, 230V, double sided | Wall or ceiling mounting, surface pendant mounting or recessed ceiling mounting in false ceilings with the included accessories. | 38m |

Ambalajda bulunan COV/44/EM montaj aksesuarları

| KOD | AÇIKLAMA |
|-----------|---|
| 927321340 | A-2134 Duvara montaj için aksesuar (beyaz) |
| 927321370 | A-2137 Asma tavan montajı için aksesuar (beyaz) |

Talep üzerine COV/44/EM için özel aksesuarlar

| KOD | AÇIKLAMA |
|-----------|---|
| 927321300 | A-2130 Tavana montaj için aksesuar seti (1 m) (beyaz) |
| 927321310 | A-2131 Tavana montaj için aksesuar seti (0,5m) (beyaz) |
| 927321320 | A-2132 Tavana montaj için aksesuar seti (0,25m) (beyaz) |
| 927321330 | A-2133 Dikey duvara montaj için aksesuar (beyaz) |



A-2134



A-2137



A-2130, A-2131, A-2132



A-2133

Talep üzerine gelen COV-44/EM aksesuarlarının montaj yöntemleri

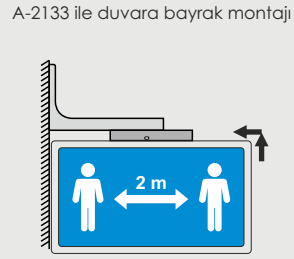
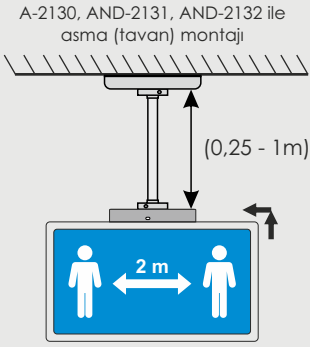

Ambalajda bulunan COV-44/EM aksesuarlarının montaj yöntemleri

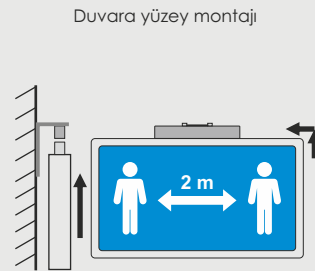
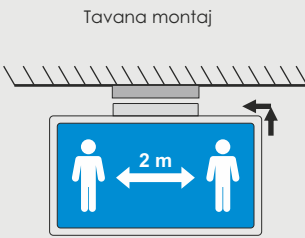
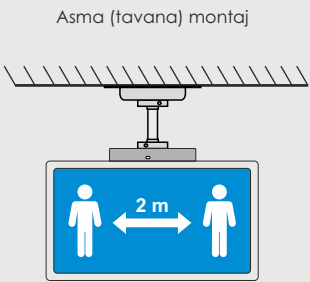

Ambalajda bulunan COV-44/DZ aksesuarlarının montaj yöntemleri

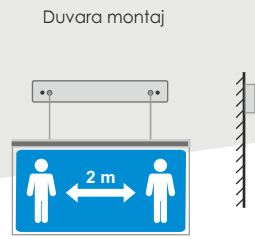
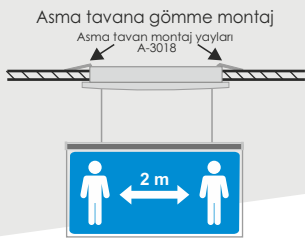
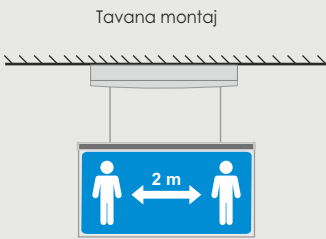

Ambalajda bulunan COV-44/SP aksesuarlarının montaj yöntemleri

